

Portable compact disc player

Service
Service
Service

AX 2100	AX 5102	AX 5113	AX 5118
AX 2101	AX 5103	AX 5114	AX 7101
AX 2102	AX 5104	AX 5115	AX 7104
AX 5100	AX 5111	AX 5116	AX 7113
AX 5101	AX 5112	AX 5117	all versions

PRODUCT FAMILY FOCUS ESP

Service Manual



TABLE OF CONTENTS

Technical specification	1-1	Blockdiagram	3-7
Connections and controls	1-2	Circuit diagrams	
Features	1-3	CD part	4-1
Accessories	1-3	Control / Supply partpart	4-2
Safety & Warnings	1-4	Audio part	4-3
Service hints		PCB layout diagram	
Repair positions	2-1	Componentside view	4-4
Dismantling CD-door	2-1	Copperside view	4-5
Handling chip components	2-2	Exploded view	5-1
Service tools	2-2	Mechanical partslist	5-1
Pin description of ICs	3-1...3-3	Electrical partslist	6-1...6-4
Start-up procedure	3-4		
Service Test Program	3-5...3-6		



© Copyright 2001 Philips Consumer Electronics B.V. Eindhoven, The Netherlands
All rights reserved. No part of this publication may be reproduced, stored in a retrieval system or transmitted, in any form or by any means, electronic, mechanical, photocopying, or otherwise without the prior permission of Philips.

Published by YT 0150 Service Audio Printed in The Netherlands Subject to modification

GB 3140 785 22870



PHILIPS

TECHNICAL SPECIFICATION

General

Dimensions (WxHxD) : 129x26x140mm
 Weight without batteries : 220g

Power supply modes

DC-in socket : 2.5-6.0V
 Primary batteries (2xLR6) : 1.7-3.6V
 Rechargeable batteries (AY3362) : 1.7-3.6V

Battery lifetime

BATTERY TYPE	ESP ON	Power Save ON
Primary batteries 2 x LR6	22 hours	25 hours
Rechargeable batteries AY3362 (1200mAh)	9 hours	10 hours

Battery level detection

DETECTION LEVEL	Primary batteries	Rechargeable batteries
Battery empty	1.8V +100/-50mV	1.8V +100/-50mV
Battery weak 1	battery empty level + 0.9V ± 100mV	battery empty level + 0.7V ± 100mV
Battery weak 2	battery empty level + 0.6V ± 100mV	battery empty level + 0.5V ± 100mV
Battery weak 3	battery empty level + 0.3V ± 100mV	battery empty level + 0.3V ± 100mV

Charge section (not on all versions)

Charge current : 250mA ±10%
 Charge time for 80% AY3362 : 4.0h nom.
 Charge time for 100% AY3362 : 6.0h nom.
 Max. charge time (µP controlled) : 7h
 Temperature protection : 50°C ±5°C

Current consumption CDDA-playback

OPERATION MODE	DC-IN SUPPLY (4.5V)		BATT. SUPPLY (2.25V)	
	ESP OFF	ESP ON	ESP OFF	ESP ON
Play-mode	100mA typ.	100mA typ.	120mA typ.	120mA typ.
Jump-mode	220mA typ.	220mA typ.	300mA typ.	300mA typ.
Charge-mode	400mA typ.		n/a	
Backlighting (additional)	50mA typ.		50mA typ.	
Stand-by (excl. recharge)	30mA typ.		50. A typ.	

Shock resistance

+X/-X direction : 2.5g
 +Y/-Y direction : 2.5g
 +Z/-Z direction : 2.0g

Headphone out (measured with 16 Ω load, DBB/ESP off)

Output power (THD=10%)
 /17 version only : 2x12mW (+1/-3dB)
 all other versions : 2x6mW (+1/-3dB)
 Frequency response (1mW) : 100Hz-20kHz within 6dB
 S/N ratio (unwght) : 80dB (83dB typ.)
 S/N ratio (A-wght) : 82dB (85dB typ.)
 THD+N (1kHz, 1mW) : 1% (0.2% typ.)
 Channel crosstalk (1kHz, no load) : -24dB (-44dB typ.)
 Channel unbalance (-40dB) : 5dB
 Volume attenuation (1kHz) : 60dB

Dynamic Bass Boost DBB

DBB STAGE	Frequency response		
	63kHz	1kHz	10kHz
DBB 1	+8dB ±2dB	0dB ±2dB	0dB ±2dB

Laser

Output power : <5mW (3mW typ.)
 Wavelength : 780nm

Measurement setup

Use Audio Signal disc SBC429 4822 397 30184

Use Audio Signal Disc SBC429 4822 397 30184 (replaces test disc 3)
 L.P.F. = 13th order filter 4822 395 30204

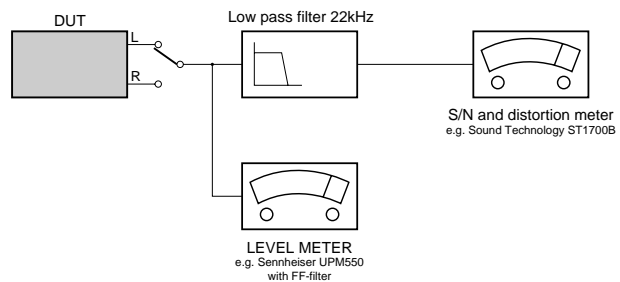

CONNECTIONS AND CONTROLS

AX21.. & AX51..

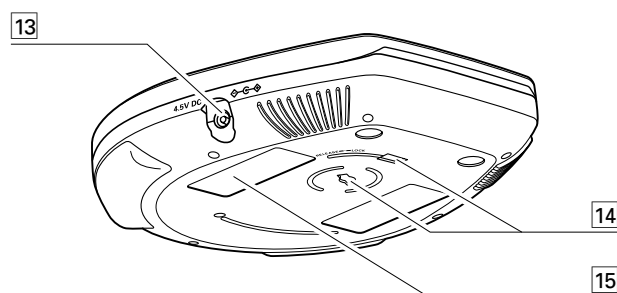
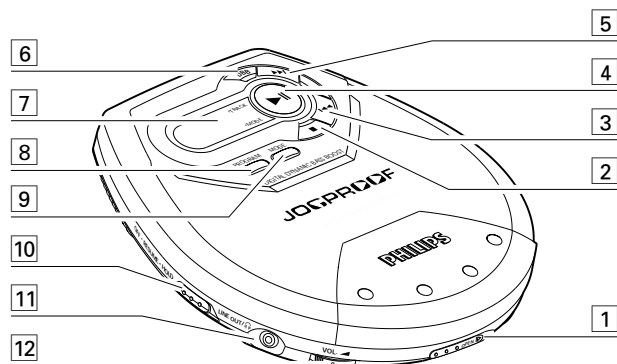

- 1 OPEN ►opens the CD lid
- 2 ■stops CD play, clears a program or switches the player off
- 3 ◀◀skips and searches CD tracks backwards
- 4 ►►switches the player on, starts or pauses CD play
- 5 ▶▶skips and searches CD tracks forwards
- 6 DBBswitches the bass enhancement on and off. This button also switches acoustic feedback (the beep) on/off when it is pressed for more than 2 seconds
- 7display
- 8 PROGRAM.....programs tracks and reviews the program
- 9 MODE.....selects the different playing possibilities: **SHUFFLE**, **SHUFFLE REPEAT ALL**, **REPEAT**, **REPEAT ALL** and **SCAN**
- 10 RESUMEstores the last position of a CD track played
 HOLDlocks all buttons
 OFFswitches RESUME and HOLD off
- 11 LINE OUT/🔊3.5 mm headphone socket, socket to connect the player to another audio input of an additional appliance, remote control socket (not on all versions)
- 12 VOL ◀adjusts the volume
- 13 4.5V DC.....socket for external power supply
- 14belt clip holder
- 15typeplate

AX71..

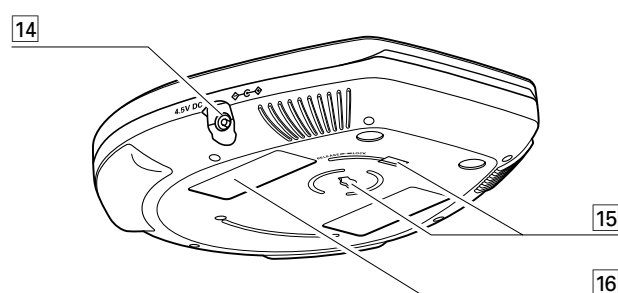
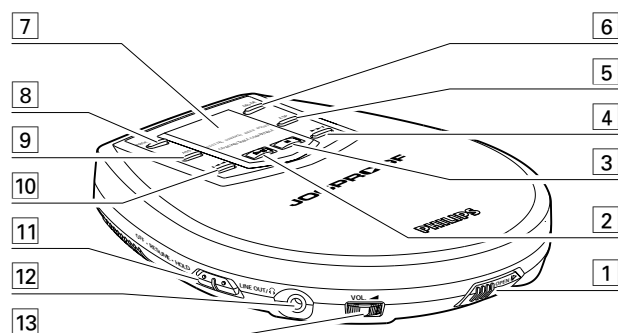

- 1 OPEN ►opens the CD lid
- 2 ►►switches the player on, starts or pauses CD play
- 3 ■stops CD play, clears a program or switches the player off
- 4 ▶▶skips and searches CD tracks forwards
- 5 ESP**ELECTRONIC SKIP PROTECTION** ensures continues CD playback regardless of vibrations and shocks
- 6 MODE.....selects the different playing possibilities: **SHUFFLE**, **SHUFFLE REPEAT ALL**, **REPEAT**, **REPEAT ALL** and **SCAN**
- 7display
- 8 PROGRAM.....programs tracks and reviews the program
- 9 BASS.....switches the bass enhancement on and off. This button also switches acoustic feedback (the beep) on/off when it is pressed for more than 2 seconds
- 10 ◀◀skips and searches CD tracks backwards
- 11 RESUMEstores the last position of a CD track played
 HOLDlocks all buttons
 OFFswitches RESUME and HOLD off
- 12 LINE OUT/🔊3.5 mm headphone socket, socket to connect the player to another audio input of an additional appliance, remote control socket (not on all versions)
- 13 VOL ◀adjusts the volume
- 14 4.5V DC.....socket for external power supply
- 15belt clip holder
- 16typeplate

For more information of operation instruction please visit Philips Audio internet site : <http://www.audio.philips.com>

FEATURES

FEATURES OF CD-PORTABLE PRODUCT FAMILY FOCUS ESP	AX2100	AX2101	AX2102	AX5100	AX5101	AX5102	AX5103	AX5104	AX5111	AX5112	AX5113	AX5114	AX5115	AX5116	AX5117	AX5118	AX7101	AX7104	AX7113
CD-RW COMPATIBILITY	●	●	●	●	●	●	●	●	●	●	●	●	●	●	●	●	●	●	●
ELECTRONIC SKIP PROTECTION	12s	12s	12s	45s	45s	45s	45s	45s	45s	45s	45s	45s	45s	45s	45s	45s	100s	100s	100s
ESP DRAM SIZE [Mbit]	16	16	16	16	16	16	16	16	16	16	16	16	16	16	16	16	32	32	32
HOLD / RESUME FUNCTION	●/●	●/●	●/●	●/●	●/●	●/●	●/●	●/●	●/●	●/●	●/●	●/●	●/●	●/●	●/●	●/●	●/●	●/●	●/●
DBB STAGES	1	1	1	1	1	1	1	1	1	1	1	1	1	1	1	1	1	1	1
ACOUSTIC FEEDBACK	●	●	●	●	●	●	●	●	●	●	●	●	●	●	●	●	●	●	●
PROGRAM MEMORY	30	30	30	30	30	30	30	30	30	30	30	30	30	30	30	30	30	30	30
RECHARGE NiCd / NiMH	--/--	--/--	●/●	--/--	--/--	●/●	--/--	●/●	--/--	●/●	--/--	--/--	--/--	--/--	--/--	--/--	--/--	●/●	--/--
BELT-CLIP	●	●	●	●	●	●	●	●	●	●	●	●	●	●	●	●	●	●	●
CORD REMOTE CONTROL	--	--	--	--	--	--	--	●	--	--	--	●	--	--	--	●	●	●	●
LINE / OPT. DIGITAL OUTPUT	--/--	--/--	--/--	--/--	--/--	--/--	--/--	--/--	--/--	--/--	--/--	--/--	--/--	--/--	--/--	--/--	--/--	--/--	--/--

ACCESSORIES

ACCESSORIES FOR CD-PORTABLE PRODUCT FAMILY FOCUS ESP		AX2100	AX2101	AX2002		AX5100	AX5101		AX5102	AX5103		AX5104		AX5111	AX5112	AX5113		AX5114	AX5115	AX5116	AX5117	AX5118	AX7101	AX7104	AX7113
		/00c	/00c	/00	/05	/00	/00c	/11	/00	/01	/10	/00c	/05	/17	/17	/00	/17	/17	/17	/17	/17	/17	/17	/17	/00
AY3170/00 AC/DC Adaptor	4822 219 10617	O	X	X		O	X		X		X					X			X					X	
AY3170/02 AC/DC Adaptor	4822 219 10676									X															
AY3170/05 AC/DC Adaptor	4822 219 10672				X							X													
AY3170/10 AC/DC Adaptor	4822 219 10681										X														
AY3170/12 AC/DC Adaptor	4822 219 10671							X																	
AY3170/17 AC/DC Adaptor	4822 219 10616													O	O			O	O	O	O	O	O	O	O
AY3266/00 Pouch (Neoprene)	3140 113 10360	O	O	O	O	O	O	O	O	O	O	O	O	O	O	O	O	O	O	O	O	O	O	O	O
AY3362/00 Rechargeable Batt. NiMH	3103 308 84120								X			X	X											X	
AY3464 HiFi Cord (3.5mm L-plug→cinch)	4822 320 11881	O	O	O	O	O	O	O	O	O	O	O	O	O	O	O	O	O	O	O	O	O	O	O	O
AY3501/00 Car Adaptor Cassette	4822 397 10059	O	O	O	O	O	O	O	X	X	O	O	O	O	O	O	O	O	X	X	X	X	X	O	X
AY3545/00 Car DC/DC Converter	4822 219 10033	O	O	O	O	O	O	O	X	X	O	O			O									O	
AY3545/17 Car DC/DC Converter	3140 118 32970													O	O			O	O	X	X	X	X	O	X
AY3768/00 Cord Remote Control	3140 118 50980											X	X					X					X	X	X
HE205/77 Headphone	9082 100 00615	X	X	X	X	X	X	X	X	X	X					X									
HE205/77s Headphone (S-plug)	9082 100 00616											X	X												
HL351/77 Headphone	9082 100 00639													X	X			X	X	X	X				
HL351/77s Headphone (S-plug)	9082 100 00641																	X					X	X	X
BELT-CLIP	3103 304 70250	X	X	X	X	X	X	X	X	X	X	X	X	X	X	X	X	X	X	X	X	X	X	X	X

X...supplied with the set, O...optional available

SAFETY & WARNINGS

(GB) WARNING

All ICs and many other semiconductors are susceptible to electrostatic discharges (ESD). Careless handling during repair can reduce life drastically.

When repairing, make sure that you are connected with the same potential as the mass of the set via a wristband with resistance. Keep components and tools at this potential.

(F) ATTENTION

Tous les IC et beaucoup d'autres semi-conducteurs sont sensibles aux décharges statiques (ESD). Leur longévité pourrait être considérablement écourtée par le fait qu'aucune précaution n'est prise à leur manipulation.

Lors de réparations, s'assurer de bien être relié au même potentiel que la masse de l'appareil et enfilez le braceleterti d'une résistance de sécurité.

Veiller à ce que les composants ainsi que les outils que l'on utilise soient également à ce potentiel.



(D) WARNUNG

Alle ICs und viele andere Halbleiter sind empfindlich gegenüber elektrostatistischen Entladungen (ESD). Unsorgfältige Behandlung im Reparaturfall kann die Lebensdauer drastisch reduzieren. Sorgen Sie dafür, daß Sie im Reparaturfall über ein Puls-armband mit Widerstand mit dem Massepotential des Gerätes verbunden sind. Halten Sie Bauteile und Hilfsmittel ebenfalls auf diesem Potential.

(NL) WAARSCHUWING

Alle IC's en vele andere halfgeleiders zijn gevoelig voor electrostatische ontladingen (ESD). Onzorgvuldig behandelen tijdens reparatie kan de levensduur drastisch doen verminderen. Zorg ervoor dat u tijdens reparatie via een polsband met weerstand verbonden bent met hetzelfde potentiaal als de massa van het apparaat. Houd componenten en hulpmiddelen ook op ditzelfde potentiaal.

(I) AVVERTIMENTO

Tutti IC e parecchi semi-conduttori sono sensibili alle scariche statiche (ESD). La loro longevità potrebbe essere fortemente ridatta in caso di non osservazione della più grande cauzione alla loro manipolazione. Durante le riparazioni occorre quindi essere collegato allo stesso potenziale che quello della massa dell'apparecchio tramite un braccialetto a resistenza. Assicurarsi che i componenti e anche gli utensili con quali si lavora siano anche a questo potenziale.

(GB) AVAILABLE ESD PROTECTION EQUIPMENT :

anti-static table mat	large 1200x650x1.25mm	4822 466 10953
	small 600x650x1.25mm	4822 466 10958
anti-static wristband		4822 395 10223
connection box	(3 press stud connections, 1MΩ)	4822 320 11307
extendible cable	(2m, 2MΩ, to connect wristband to connection box)	4822 320 11305
connecting cable	(3m, 2MΩ, to connect table mat to connection box)	4822 320 11306
earth cable	(1MΩ, to connect any product to mat or to connection box)	4822 320 11308
KIT ESD3	(combining all 6 prior products - small table mat)	4822 310 10671
wristband tester		4822 344 13999

(GB)

Safety regulations require that the set be restored to its original condition and that parts which are identical with those specified be used.

Safety components are marked by the symbol ▲

(F)

Les normes de sécurité exigent que l'appareil soit remis à l'état d'origine et que soient utilisées les pièces de rechange identiques à celles spécifiées.

Les composants de sécurité sont marqués ▲

SAFETY



(D)

Bei jeder Reparatur sind die geltenden Sicherheitsvorschriften zu beachten. Der Originalzustand des Gerätes darf nicht verändert werden. Für Reparaturen sind Originalersatzteile zu verwenden. Sicherheitsbauteile sind durch das Symbol ▲ markiert.

(NL)

Veiligheidsbepalingen vereisen, dat het apparaat in zijn oorspronkelijke toestand wordt teruggebracht en dat onderdelen, identiek aan de gespecificeerde, worden toegepast. De Veiligheidsonderdelen zijn aangeduid met het symbool ▲

(I)

Le norme di sicurezza estigono che l'apparecchio venga rimesso nelle condizioni originali e che siano utilizzati i pezzi di ricambio identici a quelli specificati. Componenti di sicurezza sono marcati con ▲

(GB) **DANGER:** Invisible laser radiation when open. AVOID DIRECT EXPOSURE TO BEAM.



(S) Varning !

Osynlig laserstrålning när apparaten är öppnad och spärren är urkopplad. Betrakta ej strålen.

(DK) Advarsel !

Usynlig laserstrålning ved åbning når sikkerhedsafbrydere er ude af funktion. Undgå udsættelse for stråling.

(FIN) Varoituis !

Avatussa laitteessa ja suojalukituksen ohitettaessa olet alttiina näkymättömälle laserisäteilylle. Älä katso säteeseen !

(GB)

After servicing and before returning the set to customer perform a leakage current measurement test from all exposed metal parts to earth ground, to assure no shock hazard exists. The leakage current must not exceed 0.5mA.

(F)

"Pour votre sécurité, ces documents doivent être utilisés par des spécialistes agréés, seuls habilités à réparer votre appareil en panne".

SERVICE HINTS

REPAIR POSITION COPPERSIDE

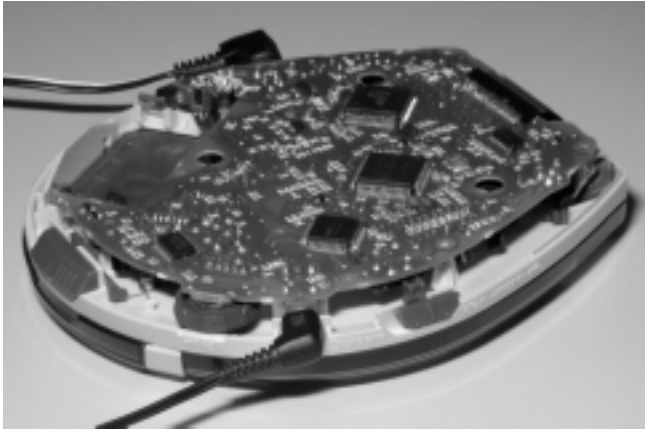

To get access to the copperside of the printed board assembly proceed as follows:

1. Remove the bottom screws (6x)
2. Lift the bottom-cabinet
3. Supply the unit via external DC-socket
4. Take care that the door switch is closed during measurements

REPAIR POSITION COMPONENTSIDE



To get access to the componentside of the printed board assembly proceed as follows:

1. Remove the bottom screws (6x)
2. Open the CD-door
3. Lift the top-cabinet and put it backwards on the table
4. Supply the unit via the external DC-socket
5. Take care that the door switch is closed during measurements

DISMANTLING THE CD-DOOR



To dismantle the CD-door proceed as follows:

1. Dismantle bottom and printed board/drive assembly
2. Disconnect membrane keyboard (flex-foil connector on copperside of printed board)
3. Bend the cabinet leftwards downwards ①, while bending the CD-door rightwards upwards ②

The procedure appears to be tricky at first, but force needs to be applied with thumb and middle finger only. It's just like snapping one's fingers.

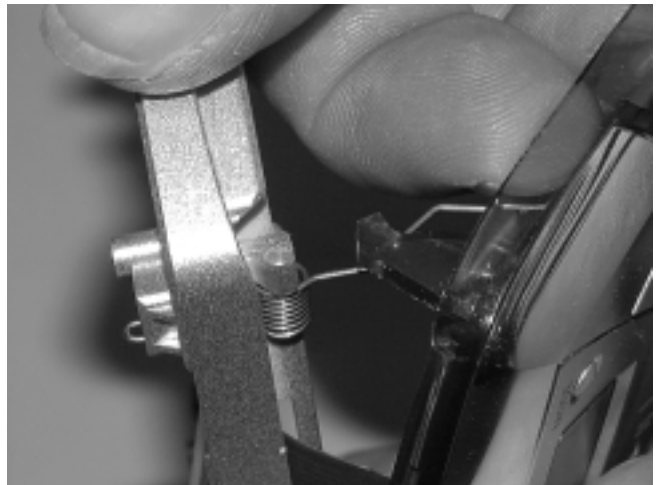

Remark: Don't worry about applied force - both parts have a solid design. However, do not use screwdrivers or tools like that. Sharp edges could damage hinge or cabinet part.

PIN DESCRIPTION OF INTEGRATED CIRCUITS

TZA1024 – HF-PREAMPLIFIER AND LASER SUPPLY CIRCUIT

<i>Pin</i>	<i>Name</i>	<i>Direction</i>	<i>Description</i>
1	LD	HF-preamp → CD-drive	current output to laser diode
2	VCCL	+2.6V	laser supply voltage
3	CFIL	→ HF-preamp	external filter capacitor
4	MON	CD-drive → HF-preamp	laser monitor diode input
5	DIN	CD-drive → HF-preamp	central diode input
6	GND	GND	ground
7	PWRON	CD10 → HF-preamp	power-on select input
8	CMFB	+2.6V / 2	common mode feedback voltage input
9	RFFB	→ HF-preamp	external RF feedback resistor
10	RFEQO	HF-preamp →	RF amplifier output
11	CDRW	CD10 → HF-preamp	gain select input for CDDA/CDRW
12	EQSEL	CD10 → HF-preamp	equalizer/speed select input
13	VCC2	+2.6V	supply voltage
14	RGADJ	GND	external laser supply gain adjust resistor

SC111259FTA – SERVO DRIVER & POWER MANAGEMENT IC

<i>Pin</i>	<i>Name</i>	<i>Direction</i>	<i>Description</i>
1	SLEEP	μP → servo driver	sleep input
2	WAKW	μP → servo driver	wake input
3	VR	+VR	reference voltage input (motor driver)
4	ERR4	CD10 → servo driver	control signal input (slide error signal)
5	CF4	→ servo driver	phase correction capacitor connect (CH4)
6	CF3	→ servo driver	phase correction capacitor connect (CH3)
7	ERR3	CD10 → servo driver	control signal input (radial error signal)
8	ERR2	CD10/μP → servo driver	control signal input (disc speed error signal)
9	CF2	→ servo driver	phase correction capacitor connect (CH2)
10	CF1	→ servo driver	phase correction capacitor connect (CH1)
11	ERR1	CD10 → servo driver	control signal input (focus error signal)
12	OUT1A	servo driver → CD-drive	positive drive output (CH1)
13	PGND1	GND	H-bridge driver ground
14	OUT1B	servo driver → CD-drive	negative drive output (CH1)
15	VIN12	+A	CH1 and CH2 H-bridge driver supply voltage
16	OUT2B	servo driver → CD-drive	negative drive output (CH2)
17	PGND2	GND	H-bridge driver ground
18	OUT2A	servo driver → CD-drive	positive drive output (CH2)
19	OUT3A	servo driver → CD-drive	positive drive output (CH3)
20	PGND2	GND	H-bridge driver ground
21	OUT3B	servo driver → CD-drive	negative drive output (CH3)
22	VIN34	+A	CH3 and CH4 H-bridge driver supply voltage
23	OUT4B	servo driver → CD-drive	negative drive output (CH4)
24	PGND4	GND	H-bridge driver ground
25	OUT4A	servo driver → CD-drive	positive drive output (CH4)
26	VG	+VG	charge pump output
27	C2H	→ servo driver	charge pump capacitor connect
28	C1H	→ servo driver	charge pump capacitor connect
29	C1L	→ servo driver	charge pump capacitor connect
30	C2L	→ servo driver	charge pump capacitor connect
31	VIN	battery → servo driver	battery supply voltage
32	RSTB	servo driver →	reset block output
33	CHGSW	servo driver → charge circuit	transistor drive output for battery charger
34	RS	charge circuit → servo driver	OpAmp non-inverting input for battery charger
35	INM2	→ servo driver	error amplifier inverting input
36	RF2	→ servo driver	error amplifier output
37	DCIN	+DC	DC power supply from AC/DC adaptor
38	VDET	servo driver →	DCIN over voltage and VIN low voltage detect output
39	VREF	servo driver →	Voltage reference circuit output
40	DTC	→ servo driver	max. duty control voltage input for power management
41	VOUT	servo driver → DC/DC converter	PWM output for power management
42	VC	→ servo driver	power management power supply
43	CGND	GND	internal ground
44	RF1	servo driver →	OpAmp output for power management
45	INM1	→ servo driver	OpAmp inverting input for power management
46	CLK	→ servo driver	clock input
47	OE	μP → servo driver	output enable for motor drivers
48	CHGON	μP → servo driver	charge enable for battery charger

SAA7324 – DECODER, DIGITAL SERVO IC AND D/A-CONVERTER CD10 (low voltage version)

<i>Pin</i>	<i>Name</i>	<i>Direction</i>	<i>Description</i>
1	HFREF	→ CD10	comparator common mode input
2	HFIN	→ CD10	comparator signal input
3	ISLICE	CD10 →	current feedback from data slicer
4	VSSA1	GND	analog ground 1
5	VDDA1	+2.6V	analog supply voltage 1
6	IREF	CD10 →	reference current output pin
7	VRIN	CD10 →	reference voltage for servo ADC's
8	D1	CD-drive → CD10	unipolar current input (central diode signal input)
9	D2	CD-drive → CD10	unipolar current input (central diode signal input)
10	D3	CD-drive → CD10	unipolar current input (central diode signal input)
11	D4	CD-drive → CD10	unipolar current input (central diode signal input)
12	R1	CD-drive → CD10	unipolar current input (satellite diode signal input)
13	R2	CD-drive → CD10	unipolar current input (satellite diode signal input)
14	VSSA2	GND	analog ground 2
15	CROUT	CD10 → X-TAL	crystal/resonator output
16	CRIN	X-TAL → CD10	crystal/resonator input
17	VDDA2	+2.6V	analog supply voltage 2
18	LN	CD10 →	DAC left channel differential output - negative
19	LP	CD10 →	DAC left channel differential output - positive
20	VNEG	GND	DAC negative reference input
21	VPOS	+2.6V	DAC positive reference input
22	RN	CD10 →	DAC right channel differential output - negative
23	RP	CD10 →	DAC right channel differential output - positive
24	SELPLL	CD10 →	selects whether internal clock multiplier PLL is used
25	TEST1	GND	test control input 1; this pin should be tied low
26	CL16	CD10 → DSP	16.9344 MHz system clock output
27	DATA	CD10 → NPC or CD10 → DSP	serial data output (3-state)
28	WCLK	CD10 → NPC or CD10 → DSP	word clock output (3-state)
29	SCLK	CD10 → NPC or CD10 → DSP	serial bit clock output (3-state)
30	EF	CD10 → NPC	C2 error flag output (3-state)
31	TEST2	GND	test control input 2; this pin should be tied low
32	KILL	CD10 →	kill output (programmable; open-drain)
33	VSSD1	GND	digital ground 2
34	V2/V3	CD10 → NPC	versatile I/O: input versatile pin 2 or output versatile pin 3 (open-drain)
35	WCLI	NPC → CD10 or DSP → CD10	word clock input (for data loopback to DAC)
36	SDI	NPC → CD10 or DSP → CD10	serial data input (for data loopback to DAC)
37	SCLI	NPC → CD10 or DSP → CD10	serial bit clock input (for data loopback to DAC)
38	RESETn	μP → CD10	power-on reset input (active low)
39	SDA	μP ↔ CD10	microcontroller interface data I/O line (open-drain output)
40	SCL	μP → CD10	microcontroller interface clock line input
41	RAB	μP → CD10	microcontroller interface R/W and load control line input (4-wire bus mode)
42	SILD	μP → CD10	microcontroller interface R/W and load control line input (4-wire bus mode)
43	STATUS	CD10 →	servo interrupt request line/decoder status register output (open-drain)
44	TEST3	GND	test control input 3; this pin should be tied low
45	RCK	→ CD10	subcode clock input
46	SUB	CD10 →	P-to-W subcode bits output (3-state)
47	SFSY	CD10 → μP	subcode frame sync output (3-state)
48	SBSY	CD10 → NPC	subcode block sync output (3-state)
49	CL11/4	CD10 → DSP	11.2896 MHz or 4.2336 MHz (for microcontroller) clock output
50	VSSD2	GND	digital ground 3
51	DOBM	CD10 →	bi-phase mark output (externally buffered; 3-state)
52	VDDD1P	+2.6V	digital supply voltage 2 for periphery
53	CFLG	CD10 →	correction flag output (open-drain)
54	RA	CD10 → servo driver	radial actuator output
55	FO	CD10 → servo driver	focus actuator output
56	SL	CD10 → servo driver	slide control output
57	VDDD2C	+2.6V	digital supply voltage 3 for core
58	VSSD3	GND	digital ground 4
59	MOTO1	CD10 → servo driver	motor output 1; versatile (3-state)
60	MOTO2	CD10 →	motor output 2; versatile (3-state)
61	V4	CD10 → HF-preamp	versatile output pin 4
62	V5	CD10 → HF-preamp	versatile output pin 5
63	V1	innerswitch → CD10	versatile input pin 1
64	LDON	CD10 → HF-preamp	laser drive on output (open-drain)

SM5907AF – COMPRESSION-TYPE ANTI-SHOCK MEMORY CONTROLLER NPC

<i>Pin</i>	<i>Name</i>	<i>Direction</i>	<i>Description</i>
1	VDD2	+2.6V	supply voltage
2	UC1	NPC ↔	μP interface extension I/O line 1
3	UC2	NPC ↔	μP interface extension I/O line 2
4	UC3	NPC ↔	μP interface extension I/O line 3
5	UC4	NPC ↔	μP interface extension I/O line 4
6	UC5	NPC ↔	μP interface extension I/O line 5
7	NACS3	NPC → DRAM	DRAM2 CAS control
8	TEST2	+2.6V	test pin
9	CLK	CD10 → NPC	16.9344MHz clock input
10	VSS	GND	ground
11	YSRDATA	CD10 → NPC	audio serial data input
12	YLRCK	CD10 → NPC	audio serial L/R clock input
13	YSCK	CD10 → NPC	audio serial bit clock input
14	ZSCK	NPC → CD10	audio serial bit clock output
15	ZLRCK	NPC → CD10	audio serial L/R clock output
16	ZSRDATA	NPC → CD10	audio serial data output
17	YFLAG	CD10 → NPC	signal processor IC RAM overflow flag
18	YFCLK	GND	crystal-controlled frame clock input
19	YBLKCK	CD10 → NPC	subcode block clock signal output
20	RESET	μP → NPC	system reset input (active low)
21	ZSENSE	NPC →	μP interface status output
22	VDD1	+2.6V	supply voltage
23	YDMUTE	→ NPC	forced mute input
24	YMLD	μP → NPC	μP interface latch clock input
25	YMDATA	μP → NPC	μP interface serial data input
26	YMCLK	μP → NPC	μP interface shift clock input
27	A10/NCAS2	NPC → DRAM	DRAM OE control output (active low)
28	CAS	NPC → DRAM	DRAM CAS control output (active low)
29	D2	NPC ↔ DRAM	DRAM data input/output 2
30	D3	NPC ↔ DRAM	DRAM data input/output 3
31	D0	NPC ↔ DRAM	DRAM data input/output 0
32	D1	NPC ↔ DRAM	DRAM data input/output 1
33	WE	NPC → DRAM	DRAM WE control output (active low)
34	RAS	NPC → DRAM	DRAM RAS control output (active low)
35	A9	NPC → DRAM	DRAM address output 9
36	A8	NPC → DRAM	DRAM address output 8
37	A7	NPC → DRAM	DRAM address output 7
38	A6	NPC → DRAM	DRAM address output 6
39	A5	NPC → DRAM	DRAM address output 5
40	A4	NPC → DRAM	DRAM address output 4
41	A0	NPC → DRAM	DRAM address output 0
42	A1	NPC → DRAM	DRAM address output 1
43	A2	NPC → DRAM	DRAM address output 2
44	A3	NPC → DRAM	DRAM address output 3

START-UP PROCEDURE - FLOW CHART

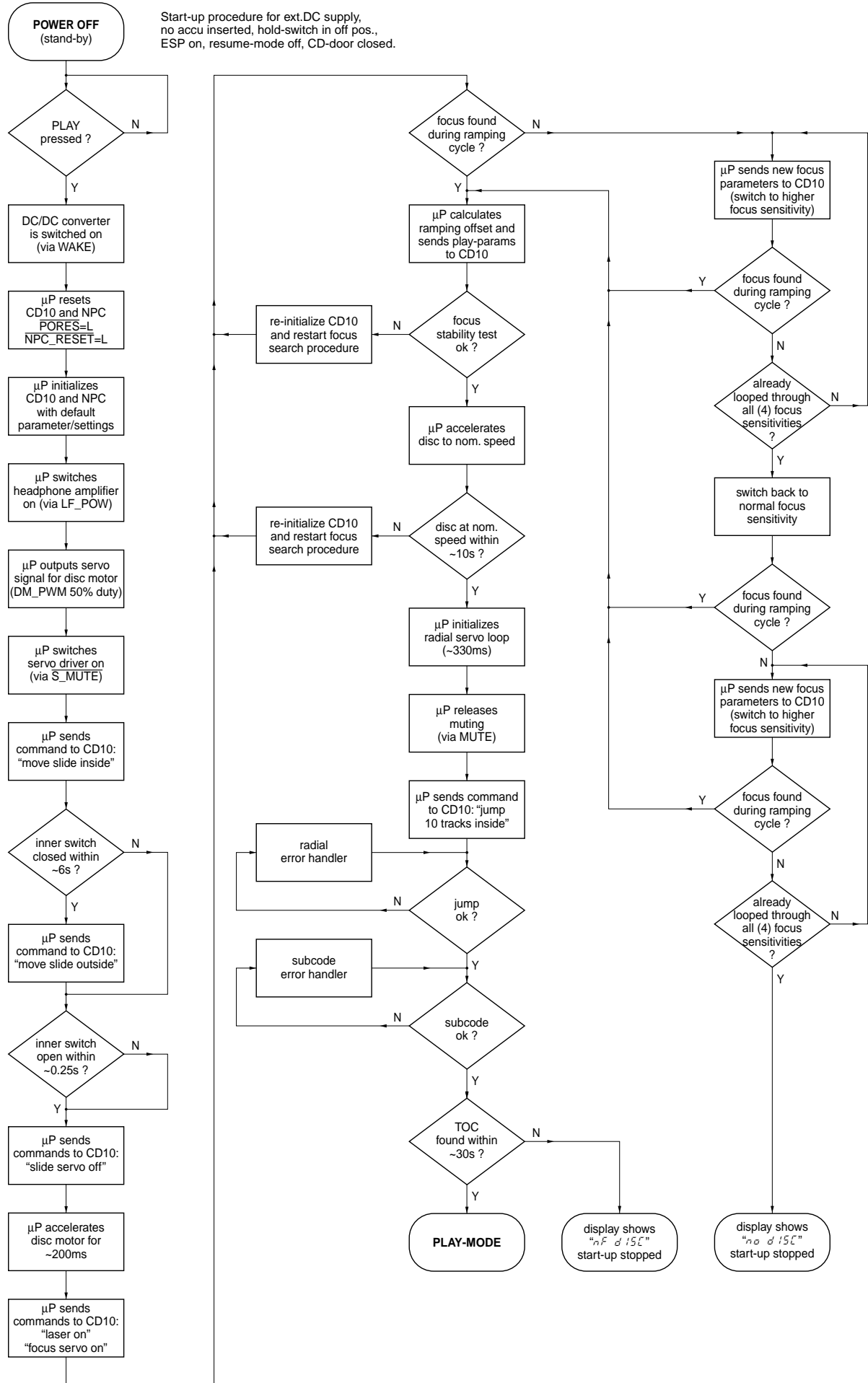

SERVICE TEST PROGRAM

1. PRELIMINARY SETUP

- To enter the service test program disconnect the AC/DC adaptor and remove batteries, open the CD-door and hold the buttons "PLAY" & "PREV" depressed while turning power on (i.e. connecting the AC/DC adaptor).
- The display shows the software version of the built-in μ P (i.e. "5-25"). Versions are counted from "00" onwards; that means the higher the number the newer the software.
- The program is now in the main menu – various tests can be entered by pressing the corresponding buttons (see flow chart on next page or detailed description of available tests below).
- To exit the service test program press the "STOP" button or disconnect the set from the power source.

2. DISPLAY TEST

Purpose: Check functionality of display and display driver.

- To enter the display test start the service test program and press the "NEXT" button.
- The display shows test pattern1. All segments are activated for finding open circuits (see flow chart on next page).
- To jump to the next pattern press the "NEXT" button.
- The display shows test pattern2. All alternate pins (2, 4, ...) are activated for finding short circuits (see flow chart on next page).
- To jump back to test pattern1 press the "NEXT" button, to exit the display test and return to the main menu press the "STOP" button.

3. KEY TEST

Purpose: Check operation of keys and cord remote control.

- To enter the key test start the service test program and press the "MODE" button.
- The display shows " - - ".
- Hold key depressed and check corresponding key code on the display. Key codes can be found in table1 (see flow chart on next page).
- To exit the key test and return to the main menu press the "STOP" button.

4. PLAYBACK TEST WITH ERROR ANALYSIS

Purpose: Analyze errors that occur during playback and search for intermittent failures.

- To enter the playback test start the service test program and press the "BASS" button.
- To start the error analysis press the "PLAY" button. Note that the playback test can only be entered if the CD-door is closed.
- The set will read the TOC and start playback.

As long as the playback is free of errors the display shows track and time information like in normal play-mode. In case of errors corresponding error codes will be displayed. The meaning of these error codes can be found in table2 (see flow chart on next page).

Note: Errors can either be "fatal" or "non fatal". Fatal errors always stop the playback, non fatal errors only cause a short interruption of the music. Fatal errors are displayed as long as the set is connected to the power source, non fatal errors are displayed until a new error occurs or a button is pressed.

- To stop the playback test disconnect the set from the power source.

5. SERVO TEST

Purpose: Check door switch, inner switch of CD-drive, movement of slide and acceleration of discmotor.

- To enter the servo test start the service test program and press the "PLAY" button.
- The display shows " $\bar{c} \bar{d} xy$ ".
"x" indicates state of door switch;
"y" indicates state of inner switch.
 $x, y = \bar{0}$ means switch is closed; "1" means switch is open.
- To move slide outside hold the "NEXT" button depressed.
- To move slide inside hold the "PREV" button depressed.
- To accelerate the discmotor clockwise hold the "MODE" button depressed.
- To accelerate the discmotor counter-clockwise hold the "PROG" button depressed.
- To enter the focus test press the "PLAY" button, to exit the servo test and return to the main menu press the "STOP" button.

6. FOCUS TEST

Purpose: Check movement of lens and operation of focus servo for CDDA and CDRW discs.

Since the CDRW reflects much less light than an ordinary CDDA, the gain of the HF-amplifier stage and the sensitivity of the ADC inside the Decoder&Digital Servo IC "CD10" must be adapted accordingly. The gain is switched via the CDRW input of the HF-preamplifier. The ADC-sensitivity is set via software parameters (sent from μ P to "CD10"). In total, there are 4 sensitivity modes available: 1 for CDDA and 3 for CDRW. The modes are listed in table3 (see next page). In normal play-mode, the correct focus sensitivity is chosen automatically during start-up (see "Start-up procedure" on previous page). In the service test program, the sensitivity can be chosen manually in order to allow individual measurements in several modes.

- The focus servo loop is switched on and the set starts searching the focus ("focus ramping"). As soon as the focus has been found the focus servo loop is closed and the state of the focus is monitored continuously.
- If the focus is OK the display shows " F x", else " - F x".
"x" indicates the sensitivity mode. Details can be found in table3 (see flow chart on next page).
- To toggle between sensitivity modes press the "BASS" button.
- To move slide outside hold the "NEXT" button depressed.
- To move slide inside hold the "PREV" button depressed.
- To accelerate the discmotor clockwise hold the "MODE" button depressed.
- To accelerate the discmotor counter-clockwise hold the "PROG" button depressed.
- In case the focus is OK the discmotor test can be entered by pressing the "PLAY" button, to exit the focus test and return to the main menu press the "STOP" button.

7. DISCMOTOR TEST

Purpose: Check speed regulation of discmotor.

- The speed regulation is switched on and the discmotor starts rotating. If the speed reaches 75% of the nom. speed the display shows " d", else " - d".
- In parallel also the state of the focus is monitored continuously (display " F x" or " - F x").
- In case the disc speed is OK and the focus is OK the radial test can be entered by pressing the "PLAY" button, to exit the discmotor test and return to the main menu press the "STOP" button.

8. RADIAL TEST

Purpose: Check if radial loop locks and an audio signal is audible at the headphone output.

- The radial servo loop is switched on, mute is released and the audio signal is audible. If the system is on track the display shows " r", else " - r".
- In parallel also the disc speed (display " d" or " - d") and the state of the focus (display " F x" or " - F x") are monitored continuously.
Note: In case of radial errors the audio output is muted and muting is not released automatically when the systems recovers from the error. " - r" remains on the display.
To open mute again press the "NEXT" or "PREV" button.
- To jump 16 tracks outside press the "NEXT" button.
- To jump 16 tracks inside press the "PREV" button.
- To exit the radial test and return to the main menu press the "STOP" button, to exit the service test program disconnect the set from the power source.

Important remark:

In radial test mode data to the DRAM is written at 1.2 times the nominal speed, and read from the DRAM at nominal speed. Because writing is done faster than reading the DRAM gets full after a certain time.

In normal play mode the system would now wait until the DRAM is partly emptied again, jump backwards and resume filling at the last written position. However, in radial test mode the jumps would disturb measurements on the radial servo loop. Therefore this function has been disabled and filling restarts immediately from the current position of the pick-up unit. As a result "jumps" are audible during playback.

SERVICE TEST PROGRAM – FLOW CHART

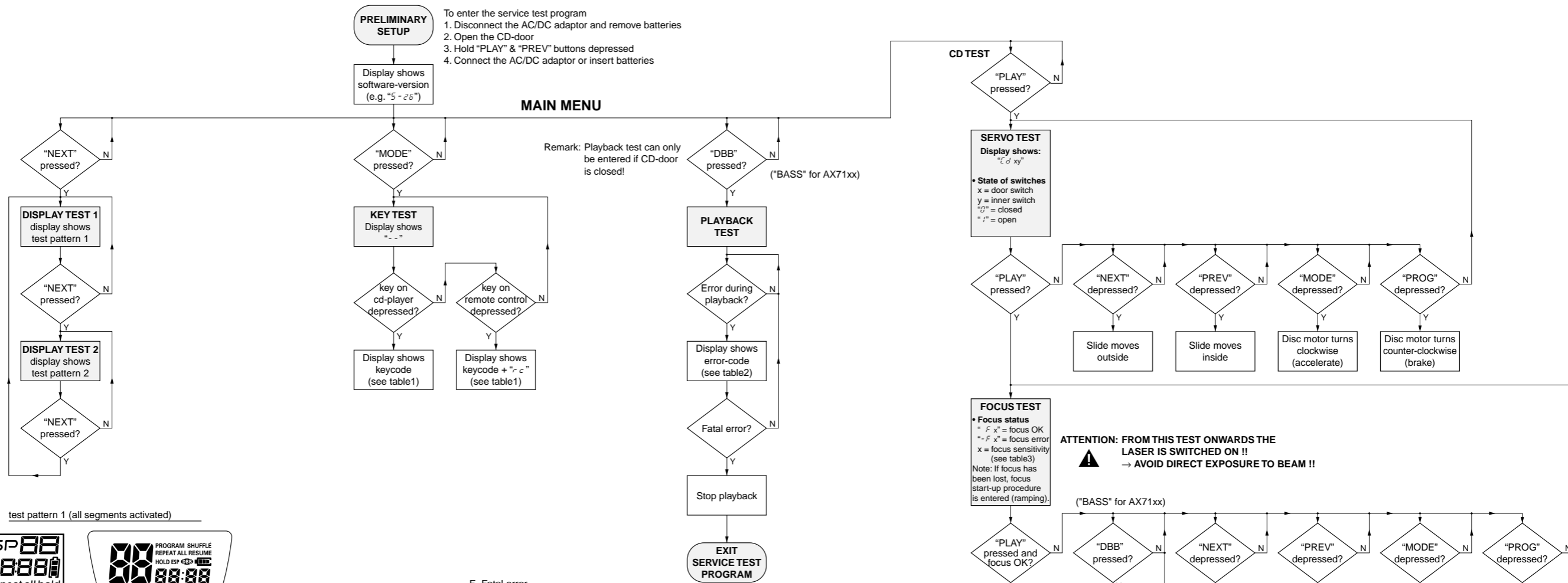

test pattern 1 (all segments activated)



test pattern 2 (alternate segments activated)

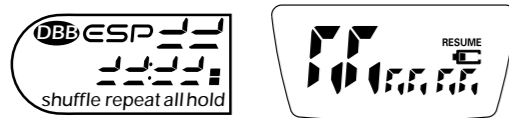

AX21..
AX51..

AX71..

table1 – key test

KEYS OF SET	DISPLAY SET
DBB (or BASS)	1
PROGRAM	2
MODE	3
PLAY	5
NEXT	6
PREVIOUS	7
ESP	8
KEYS OF CORD REMOTE CONTROL	
STOP	4 r c
PLAY	5 r c
NEXT	6 r c
PREVIOUS	7 r c

Press "STOP" on the CD-player to exit the key test.

table2 – playback error analysis

CODE	ERROR	TYPE	CAUSE
1000	focus error	W	Focus point lost for at least 3ms.
1001	radial error	W	The radial servo was offtrack for a certain amount of time.
1002	sledge in error	W	The slide did not reach it's inner pos. (inner switch of CD-drive does not close) within approx. 6s.
1003	sledge out error	W	The slide did not come out of it's inner pos. (inner switch of CD-drive is open) within approx. 250ms.
1004	DRAM filling error	W	The DRAM controller was not able to connect two consecutive audio frames. The microcontroller had to perform a direct audio connection that produces audible clicks.
1005	jump error	W	The offtrack values do not decrease properly when jumping tracks, the jump destination could not be found.
1006	subcode error		No valid subcode for approx. 230ms.
1008	turntable motor error	F	During start-up, the disc speed did not reach 75% of the nom. speed within approx. 6 seconds.
1009	audio error (error flag)	W	Uncorrectable audio error (EF error flag from CD-Decoder).
1020	focus search error	F	The focus point could not be found within approx. 10s (no valid TOC info), resp. 30s (valid TOC info).

table3 – focus sensitivity

DISPLAY	ESP-FLAG	FOCUS SENSITIVITY
- F 0 1	off	Normal focus sensitivity for CDDA
- F 0 2	on	Low focus sensitivity for high-reflective CD-RW
- F 0 3	on	Medium focus sensitivity for normal-reflective CD-RW
- F 0 4	on	High focus sensitivity for low-reflective CD-RW

BLOCKDIAGRAM

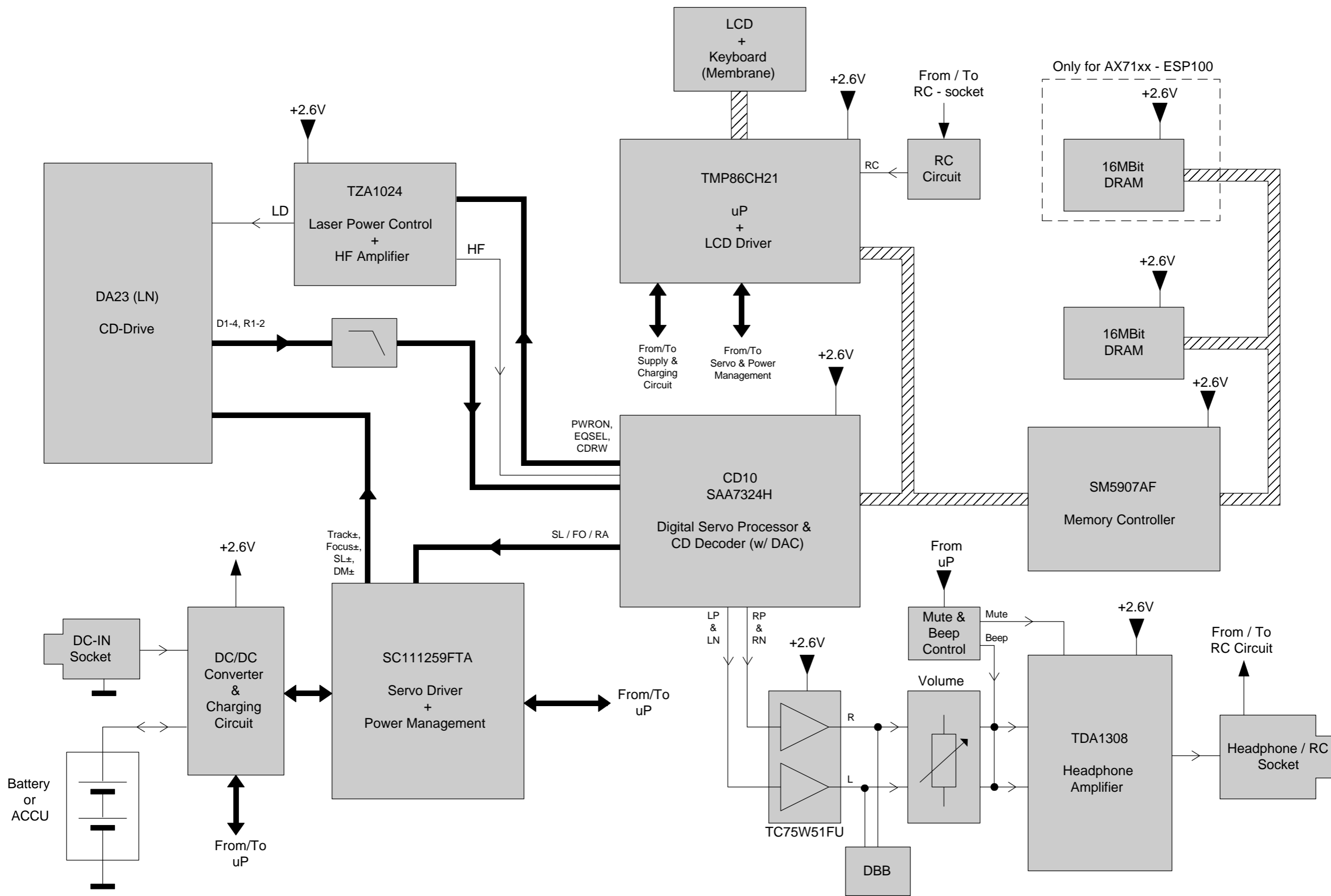

CIRCUIT DIAGRAM - CD PART

1830 B1	2803 C4	2832 E3	2837 E4	2842 E5	2847 B5	2852 A9	2857 F5	2862 B9	2866 D13	2891 C4	3802 B2	3807 C5	3832 C2	3837 D3	3842 D4	3847 C4	3852 A7	3857 A10	3862 C10	3866 F6	3874 C5	3880 D11	3885 H13	3890 D14	7830 B9	F830 C1	F835 C1	F840 E1	F845 F9	F850 B1	F856 G6	F861 G14
1840 E5	2804 C5	2833 E3	2838 E4	2843 C4	2848 B5	2853 A10	2858 F6	2863 E11	2887 C14	2892 C15	3805 B4	3808 C3	3833 C2	3838 D3	3843 D4	3848 C4	3853 A8	3858 A10	3863 C10	3869 G7	3875 B4	3881 E11	3886 H14	3909 E11	7880 D11	F831 C1	F836 D1	F841 D1	F846 B8	F851 B4	F857 G7	F862 F14
2800 A1	2805 C2	2834 E3	2839 E4	2844 C4	2849 C5	2854 A10	2859 F7	2881 H13	2888 F7	2893 C11	3804 A5	3809 B1	3834 C2	3839 D3	3844 D4	3849 B5	3854 A9	3859 A10	3864 C10	3871 F8	3876 C4	3882 G12	3887 G14	5800 F8	7881 C11	F832 C1	F837 D1	F842 D1	F847 G8	F852 B6	F858 F7	F863 C13
2801 B2	2830 D1	2835 E3	2840 E5	2845 C4	2850 A9	2855 A10	2860 F7	2882 G14	2889 H12	3800 A1	3805 B4	3830 C1	3835 E2	3840 D3	3845 E4	3850 C5	3855 A9	3860 C10	3865 F9	3872 F8	3877 F7	3883 G12	3888 G15	7800 A2	7882 H14	F833 C1	F838 D1	F843 E1	F848 A1	F854 C5	F859 D10	F864 F14
2802 B5	2831 E2	2836 E3	2841 E5	2846 B5	2851 A9	2856 D10	2861 B7	2885 C13	2890 B4	3801 B1	3806 C4	3831 C2	3836 E2	3841 D4	3846 E4	3851 B5	3856 A9	3861 C10	3867 F5	3873 F8	3878 F7	3884 G13	3889 G14	7801 C3	7883 C14	F834 C1	F839 D1	F844 C5	F849 A2	F855 G6	F860 E11	

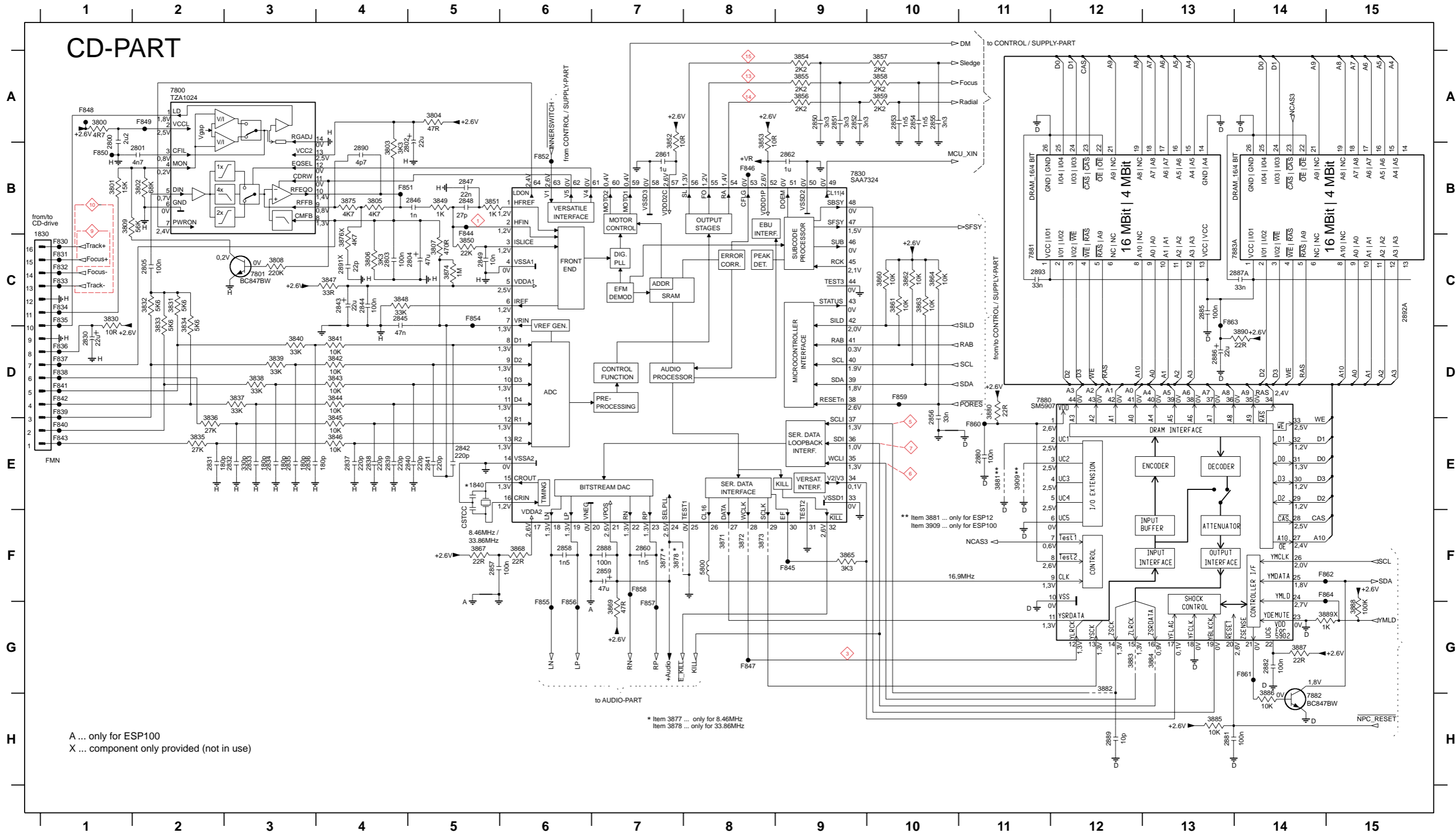

A ... only for ESP100
X ... component only provided (not in use)

* Item 3877 ... only for 8.46MHz
Item 3878 ... only for 33.86MHz

** Item 3881 ... only for ESP12
Item 3909 ... only for ESP100

CIRCUIT DIAGRAM - CONTROL/SUPPLY PART

1250 H4	1402 B15	2254 B6	2259 D7	2264 E7	2269 G4	2277 E8	2402 E10	2701 H4	3252 C6	3257 D6	3266 E4	3279 H2	3284 E1	3290 G8	3295 D6	3402 B14	3407 E10	3412 D15	3421 B14	3703 H15	3708 H15	5251 B7	7251 C6	7260 H3	7702 H14	F254 E2	F259 H5	F400 B11	F405 C15	F410 B11	F415 B12	F420 B13	F425 H10	F430 D15
1251 A2	2250 A6	2255 C7	2260 D6	2265 F4	2272 G5	2278 D8	2403 E10	2702 H5	3253 C3	3258 D2	3268 E8	3280 H2	3285 F1	3291 D8	3297 D5	3403 B15	3408 E10	3413 E15	3422 E10	3704 H15	3709 H14	6252 C2	7252 C2	7400 C10	F250 E1	F255 A8	F260 H5	F401 C13	F406 C15	F411 B11	F416 B12	F421 B13	F426 F1	F431 G14
1252 D1	2251 A2	2256 C7	2261 D1	2266 F8	2273 G6	2279 E8	2404 E10	3202 D5	3254 C5	3259 D2	3269 E8	3281 H3	3286 F1	3292 D8	3298 E3	3404 B14	3409 E10	3414 A15	3700 H15	3705 H15	3710 H14	6257 E2	7255 E2	7401 A14	F251 B1	F256 B8	F261 D1	F402 B13	F407 B11	F412 B11	F417 B12	F422 B13	F427 B13	F432 G13
1400 B10	2252 B6	2257 C8	2262 D4	2267 F4	2275 F8	2400 F15	2405 G12	3250 B7	3255 C5	3260 D6	3270 E2	3282 H2	3288 B7	3293 E4	3400 A13	3405 C14	3410 G12	3418 C15	3701 H14	3706 H14	3910 F8	6400 A12	7256 D4	7700 H15	F252 A1	F257 H4	F262 C5	F403 C13	F408 B11	F413 B12	F418 B12	F423 B13	F428 D8	F433 G12
1401 B14	2253 B6	2258 D5	2263 E8	2268 F8	2276 F8	2401 G12	2700 H14	3251 C2	3256 C7	3261 C4	3271 E1	3283 I2	3289 F8	3294 G4	3401 B14	3406 C14	3411 F15	3419 C15	3702 H15	3707 H14	5250 B6	7250 B7	7259 H2	7701 H15	F253 E1	F258 H5	F263 D9	F404 B14	F409 B11	F414 B12	F419 B12	F424 B13	F429 F4	F434 G12

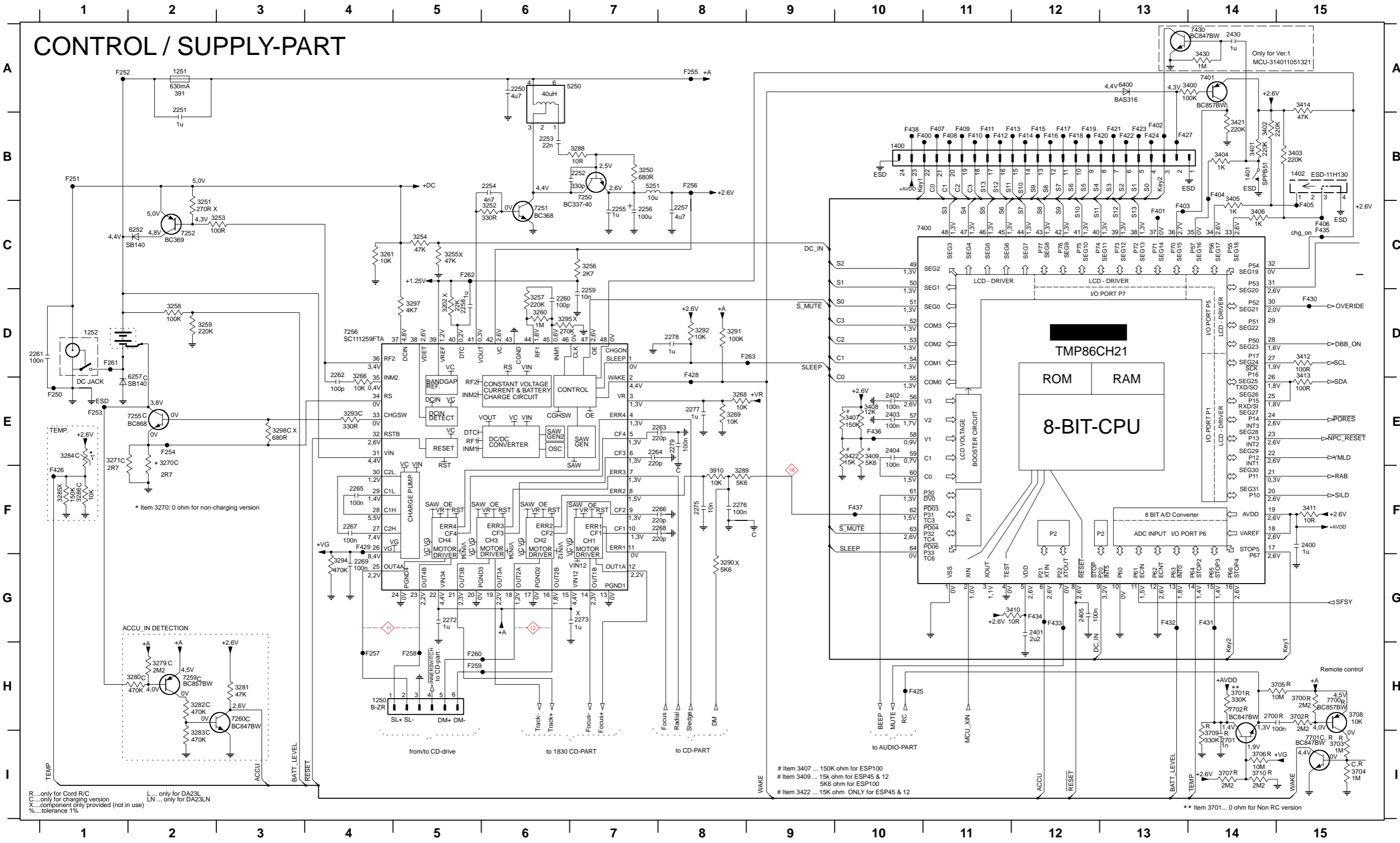

R... only for Cord R/C
 C... only for charging version
 X... component only provided (not in use)
 %... tolerance 1%

Item 3407 ... 150K ohm for ESP100
 # Item 3409 ... 15k ohm for ESP45 & 12
 5K6 ohm for ESP100
 # Item 3422 ... 15K ohm ONLY for ESP45 & 12

** Item 3701... 0 ohm for Non RC version

CIRCUIT DIAGRAM - AUDIO PART

1300 B10	2306 D1	2320 D7	2333 E3	2343 E8	3312 C1	3318 C2	3328 D5	3340 D7	3346 D9	3361 C6	3368 E2	3375 B5	3381 D8	6302 C8	7302 C7	7309 B9	F302 D10	F309 C4
2301 A2	2313 C5	2321 B8	2335 E2	2344 C8	3313 B1	3320 C3	3333 C8	3341 B7	3347 B9	3362 C7	3370 B3	3376 C5	3382 C8	6303 C9	7303 B4	7310 D9	F304 C2	F310 E2
2302 C2	2314 C5	2322 D8	2339 E3	2345 B7	3314 D1	3323 B5	3334 E8	3342 D7	3348 C9	3364 D3	3371 B3	3377 B6	3383 C8	7300-A D2	7304 C4	7311 B7	F305 B10	F311 E3
2303 B1	2315 B6	2325 C10	2340 C2	2346 D7	3315 B1	3324 D5	3337 A7	3343 B8	3349 B9	3365 E3	3372 C4	3378 D6	3384 B6	7300-B B2	7305 C7	7831 B4	F306 B2	
2304 D1	2316 D6	2326 C10	2341 B2	2894 D10	3316 D1	3326 B10	3338 D7	3344 D8	3350 D9	3366 E3	3373 C4	3379 C4	6300 C10	7301-A D7	7306 E7	F105 D3	F307 B6	
2305 B1	2319 B7	2332 C4	2342 C6	3311 B1	3317 A2	3327 B5	3339 B7	3345 B9	3360 C5	3367 E2	3374 C4	3380 B8	6301 E5	7301-B B7	7308 C6	F301 B10	F308 D6	

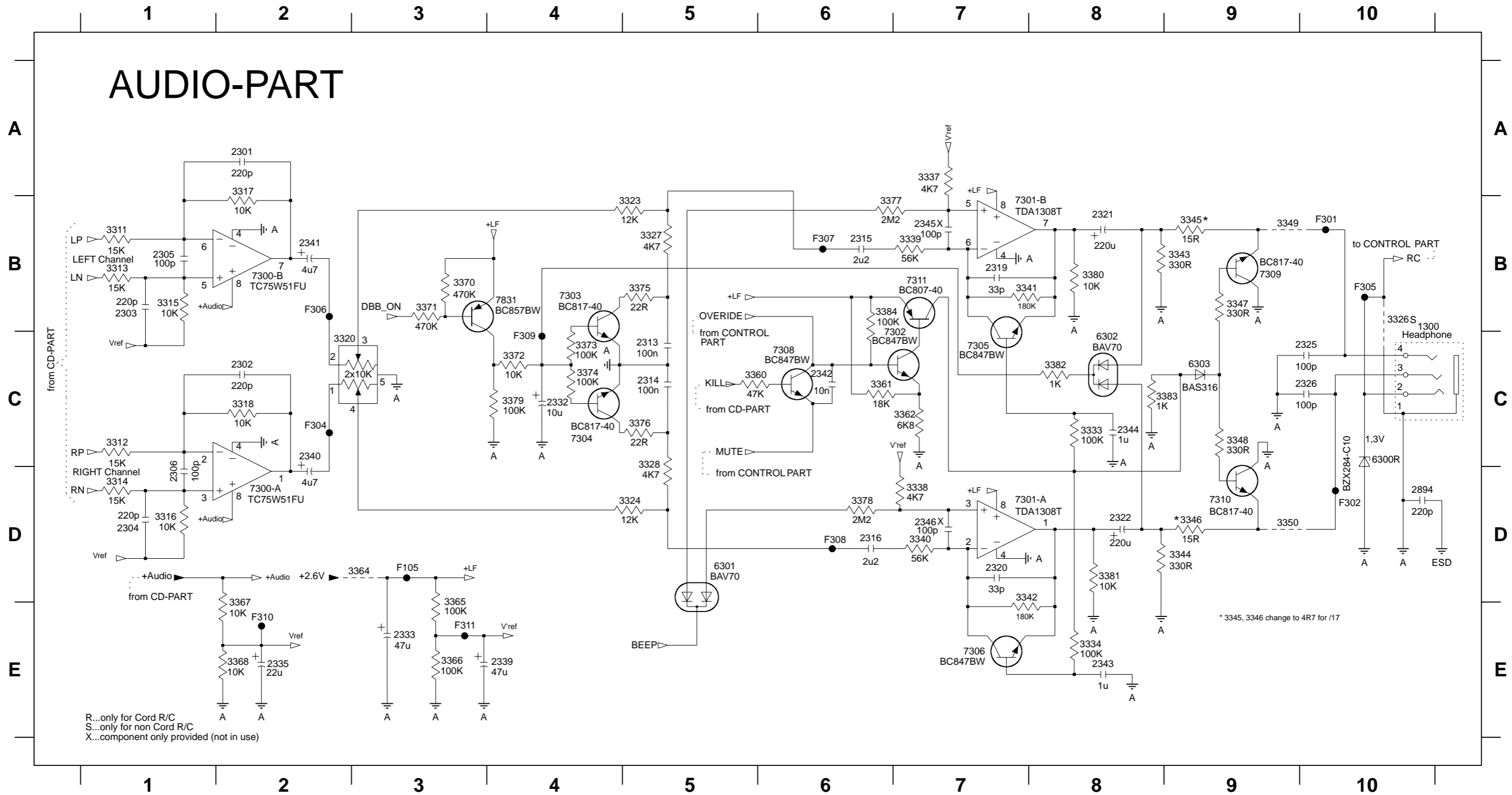

PCB LAYOUT DIAGRAM - COMPONENT SIDE

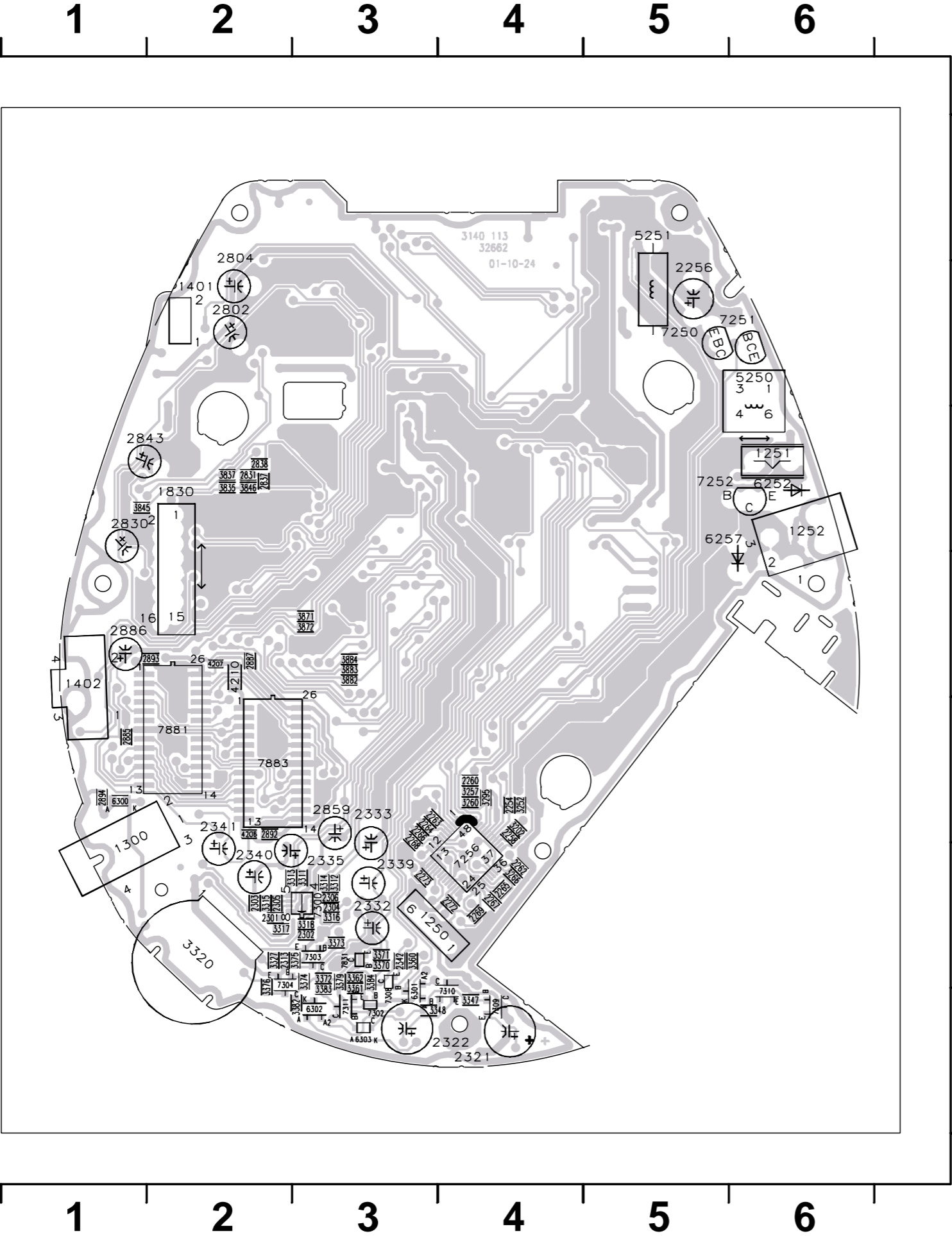

1250 F3	2887 D2	4210 D2
1251 C6	2892 E2	5250 B6
1252 C6	2893 D2	5251 A5
1300 F1	2894 E1	6252 C6
1401 B2	3202 E4	6257 C5
1402 D1	3252 E4	6300 E1
1830 C2	3257 E4	6301 G3
2254 E4	3260 E4	6302 G3
2256 B5	3266 F4	6303 G3
2258 E4	3295 E4	7250 B5
2260 E4	3311 F3	7251 B6
2262 F4	3312 F3	7252 C5
2263 E3	3313 F2	7256 F4
2264 E3	3314 F3	7300 F3
2265 F4	3315 F2	7302 G3
2266 E3	3316 F3	7303 F3
2267 F4	3317 F2	7304 F2
2268 E3	3318 F3	7308 G3
2269 F4	3320 F2	7309 G4
2272 F4	3327 F2	7310 G4
2273 F3	3347 G4	7311 G3
2301 F2	3348 G3	7831 F3
2302 F3	3360 F3	7881 E2
2303 F2	3361 G3	7883 E2
2304 F3	3362 F3	
2305 F2	3370 F3	
2306 F3	3371 F3	
2313 F2	3372 F3	
2321 G4	3373 F3	
2322 G4	3374 F3	
2332 F3	3375 F3	
2333 E3	3376 F2	
2335 F3	3379 F3	
2339 F3	3382 G3	
2340 F2	3383 G3	
2341 E2	3384 F3	
2342 F3	3835 C2	
2802 B2	3837 C2	
2804 A2	3845 C1	
2830 C1	3846 C2	
2831 C2	3871 D3	
2837 C2	3872 D3	
2838 C2	3882 D3	
2843 C1	3883 D3	
2859 E3	3884 D3	
2885 E1	4206 E2	
2886 D1	4207 D2	

PCB LAYOUT DIAGRAM - COPPER SIDE

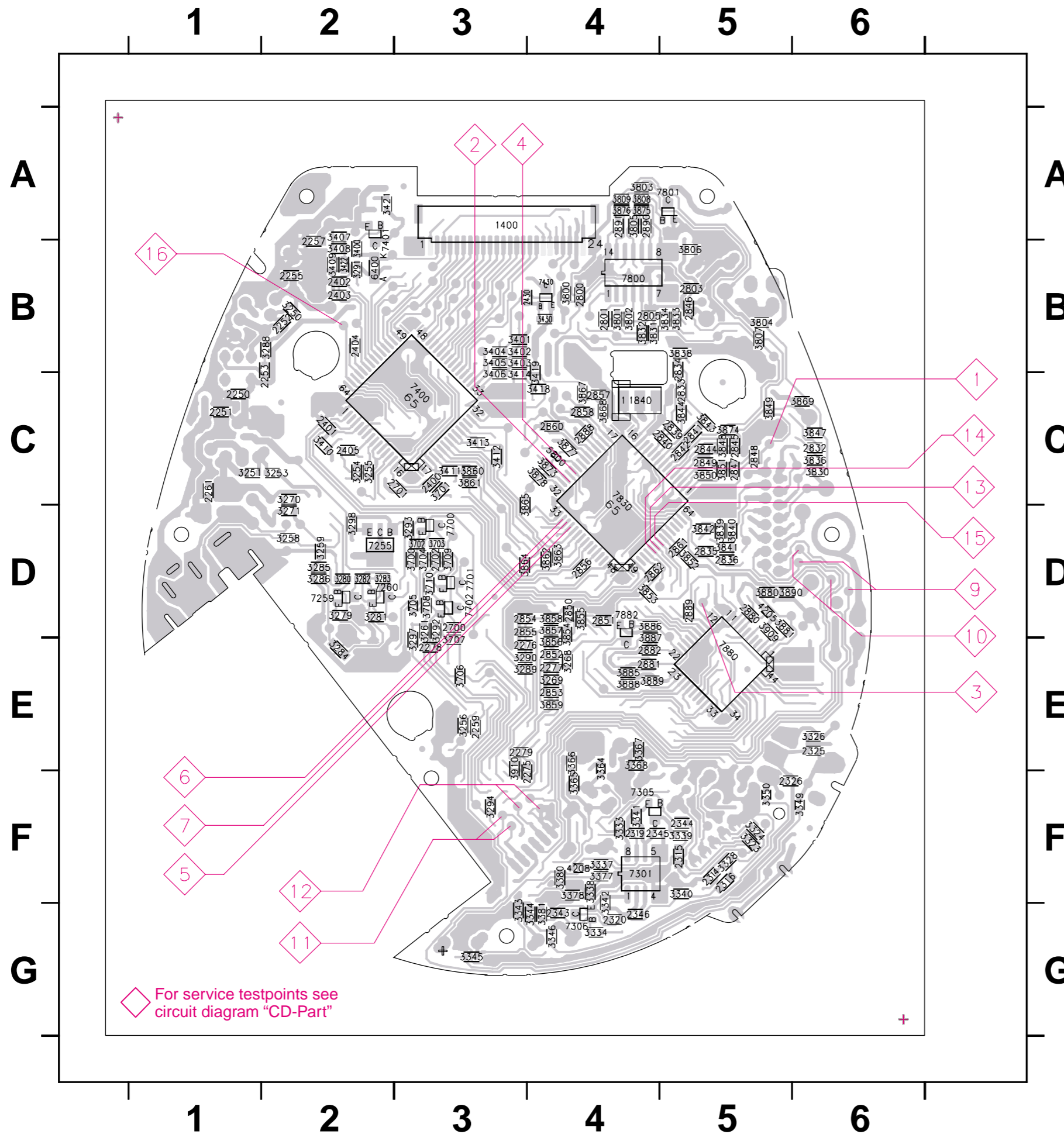

1400 A3	2841 C5	3286 D2	3410 C2	3850 C5	7430 B4
1840 C4	2842 C5	3288 B2	3411 C3	3851 C5	7700 D3
2250 C1	2844 C5	3289 E3	3412 C3	3852 D5	7701 D3
2251 C1	2845 C5	3290 E3	3413 C3	3853 D4	7702 D3
2252 B2	2846 B5	3291 B2	3414 C3	3854 D4	7800 B4
2253 B2	2847 C5	3292 D3	3418 C4	3855 D4	7801 A5
2255 B2	2848 C5	3293 D3	3419 C4	3856 E4	7830 C4
2257 B2	2849 C5	3294 F3	3421 A2	3857 D4	7880 E5
2259 E3	2850 D4	3297 E3	3422 B2	3858 D4	7882 D4
2261 C1	2851 D4	3298 D2	3430 B4	3859 E4	
2275 F4	2852 E4	3323 F5	3700 D3	3860 C3	
2276 E3	2853 E4	3324 F5	3701 C3	3861 C3	
2277 E4	2854 D3	3326 E6	3702 D3	3862 D4	
2278 E3	2855 D3	3328 F5	3703 D3	3863 D4	
2279 E3	2856 D4	3333 F4	3704 D3	3864 D3	
2314 F5	2857 C4	3334 G4	3705 D3	3865 D3	
2315 F5	2858 C4	3337 F4	3706 E3	3867 C4	
2316 F5	2860 C4	3338 F4	3707 E3	3868 C4	
2319 F4	2861 D5	3339 F5	3708 D3	3869 C6	
2320 G4	2862 D4	3340 F5	3709 D3	3873 C4	
2325 E6	2880 D5	3341 F4	3710 D3	3874 C5	
2326 F5	2881 E4	3342 F4	3800 B4	3875 A4	
2343 G4	2882 E4	3343 G3	3801 B4	3876 A4	
2344 F5	2888 C4	3344 G4	3802 B4	3877 C4	
2345 F4	2889 D5	3345 G3	3803 A4	3878 C4	
2346 G4	2890 A4	3346 G4	3804 B5	3880 D5	
2400 C3	2891 A4	3349 F6	3805 A4	3881 D5	
2401 C2	3250 B2	3350 F5	3806 B5	3885 E4	
2402 B2	3251 C1	3364 E4	3807 B5	3886 D4	
2403 B2	3253 C2	3365 F4	3808 A4	3887 E4	
2404 B2	3254 C2	3366 E4	3809 A4	3888 E4	
2405 C2	3255 C2	3367 E4	3830 C6	3889 E4	
2430 B3	3256 E3	3368 E4	3831 B4	3890 D5	
2700 D3	3258 D2	3377 F4	3832 B4	3909 D5	
2701 C3	3259 D2	3378 F4	3833 B5	3910 E3	
2702 D3	3261 D3	3380 F4	3834 B5	4205 D5	
2800 B4	3268 E4	3381 G4	3836 C6	4208 F4	
2801 B4	3269 E4	3400 B2	3838 B5	5800 C4	
2803 B5	3270 C2	3401 B3	3839 D5	6400 B2	
2805 B4	3271 D2	3402 B3	3840 D5	7255 D2	
2832 C6	3279 D2	3403 B3	3841 D5	7259 D2	
2833 C5	3280 D2	3404 B3	3842 D5	7260 D2	
2834 B5	3281 D2	3405 B3	3843 C5	7301 F4	
2835 D5	3282 D2	3406 C3	3844 C5	7305 F4	
2836 D5	3283 D2	3407 A2	3847 C6	7306 G4	
2839 C5	3284 E2	3408 B2	3848 C5	7400 C3	
2840 C5	3285 D2	3409 B2	3849 C5	7401 B2	

**EXPLODED VIEW
DESIGN "P"**

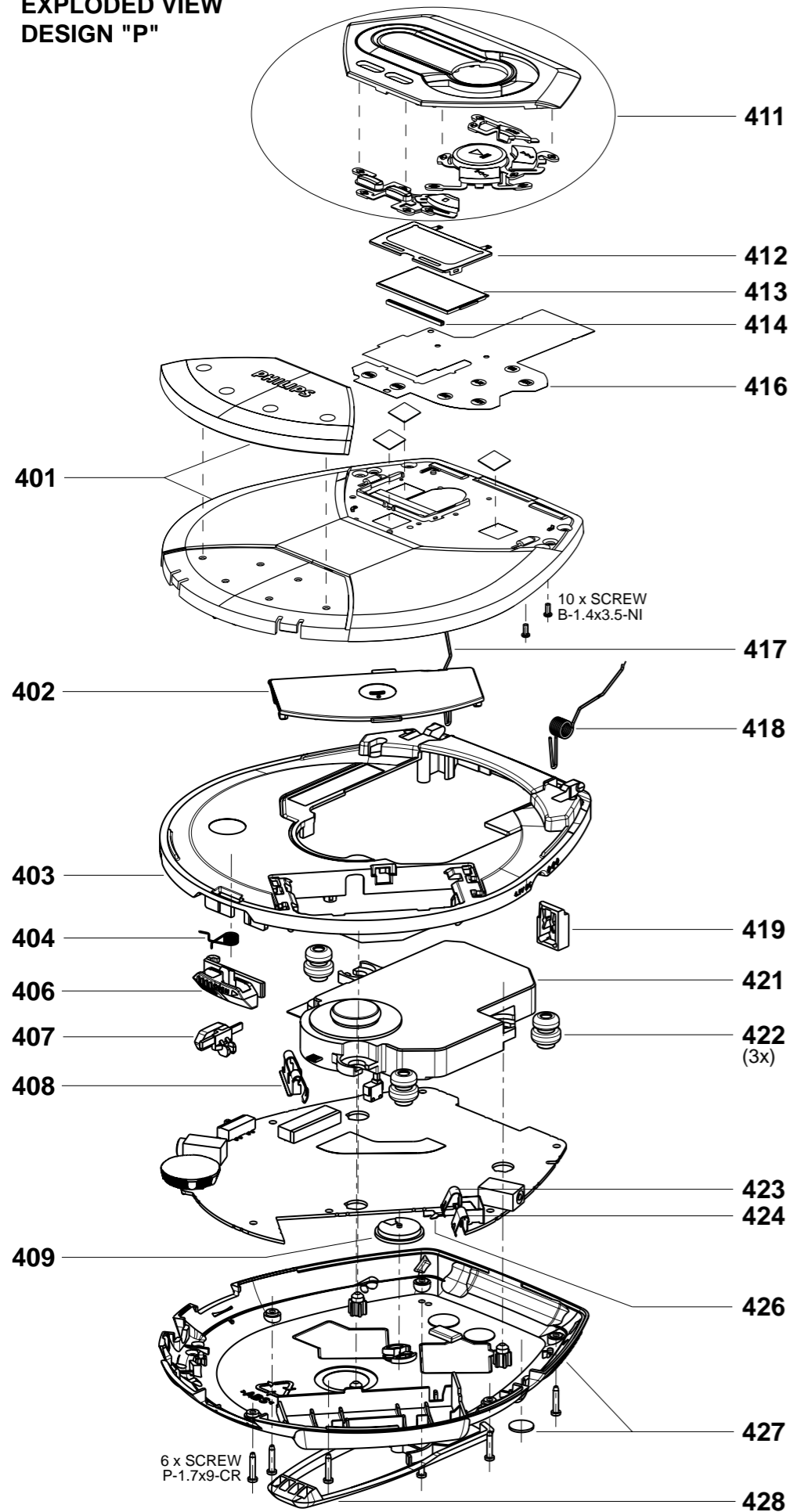

**EXPLODED VIEW
DESIGN "Q"**

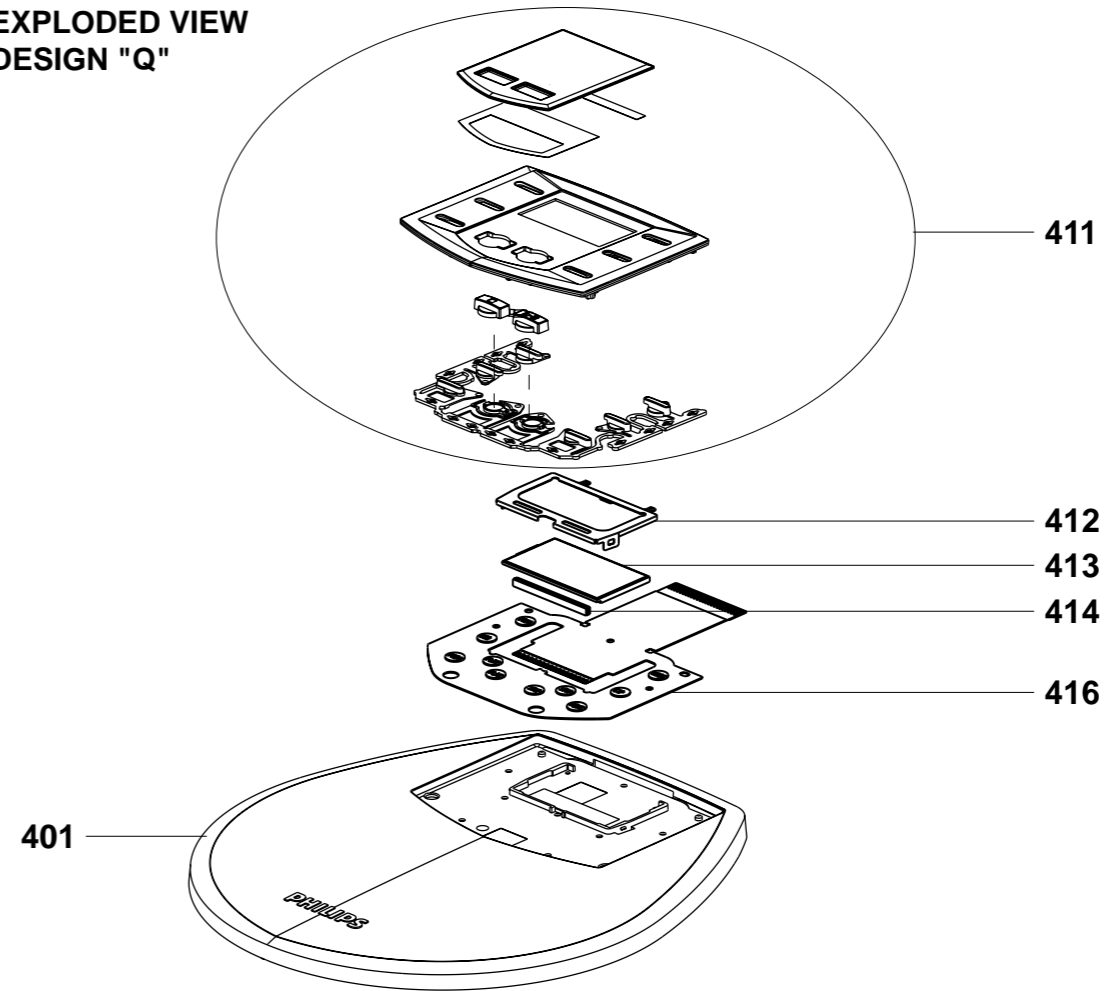

MECHANICAL PARTSLIST

401	SEE TABLE	CD-DOOR-ASSY
402	3103 304 70320	DOOR-BATTERY-2
403	3103 307 99610	CABINET - ASSY - 1
403	3103 307 99710	CABINET - ASSY - 2
404	3103 301 06500	SPRING-SLIDER-OPEN-2
406	3103 304 69580	SLIDER-OPEN
407	3103 304 69570	SLIDER-RESUME
408	3103 301 45180	SPRING-BATTERY-SHORT-2
411	SEE TABLE	PANEL-ASSY
414	3103 304 69510	ZEBRASTRIP
416	3140 113 32640	MEMBRANE-KEYBOARD (AX21xx, AX51xx)
416	3103 304 69680	MEMBRANE-KEYBOARD (AX71xx)
417	3140 111 01110	CD-DOOR-SPRING-LEFT
418	3140 111 01150	CD-DOOR-SPRING-RIGHT
421	3103 309 05320	CD DA23LNPH DRIVE ASSY
422	3103 304 69590	SUSPENSION
423	3103 301 45410	SPRING-BATTERY-MINUS
424	3103 301 45420	SPRING-BATTERY-PLUS
426	3103 301 45430	SPRING-BATTERY-CHARGE
427	3103 307 99620	BOTTOM-ASSY-1 (not for /17)
427	3103 307 99860	BOTTOM-ASSY-1 (only for /17)
428	3103 304 70250	BELT CLIP
	4822 462 41819	RUBBER FOOT

TYPE NO.	COLOUR	401 DOOR-CD ASSY	403 CABINET ASSY	411 PANEL ASSY
AX2100	Translucent blue	3140 117 62760	3103 307 99610	3140 117 62110
AX2101	blue	3140 117 62760	3103 307 99610	3140 117 62110
AX2102	Silver	3140 117 62770	3103 307 99710	3140 117 61730
AX5100	Black	3140 117 62100	3103 307 99710	3140 117 61730
AX5101	Black	3140 117 62100	3103 307 99710	3140 117 61730
AX5102	Silver	3140 117 62880	3103 307 99710	3140 117 62110
AX5103	Red	3140 117 61720	3103 307 99710	3140 117 61730
AX5104	Silver	3140 117 62880	3103 307 99710	3140 117 62110
AX5111	Translucent blue	3140 117 62820	3103 307 99610	3140 117 62110
AX5112	Silver	3140 117 62830	3103 307 99710	3140 117 61730
AX5113	Red	3140 117 61720	3103 307 99710	3140 117 61730
AX5114	Red	3140 117 61720	3103 307 99710	3140 117 61730
AX5115	Translucent blue	3140 117 62820	3103 307 99610	3140 117 62110
AX5116	Red	3140 117 61720	3103 307 99710	3140 117 61730
AX5117	Green	3140 117 63340	3103 307 99710	3140 117 61730
AX5118	Black	3140 117 62100	3103 307 99710	3140 117 61730
AX7101				
AX7104	Black Rose	3140 117 61740	3103 307 99710	3140 117 61750
AX7113				

ELECTRICAL PARTSLIST

- MISCELLANEOUS -

1003	3140 110 51310	LCD PANEL (AX21../AX51..)
1003	3103 308 84250	LCD PANEL (AX71..)
1250	2422 025 12272	CONN. 6P, CD DRIVE
1251	△ 2422 086 10946	FUSE 630MA 65VA
1252	2422 026 05086	DC SOCKET
1300	2422 026 05204	SOCKET-HEADPHONE
1300	2422 026 05203	SOCKET-H/P (RC)
1400	4822 265 11248	CONN. 24P, MEMBRANE
1401	4822 276 12889	SWITCH, CD DOOR
1402	2422 127 00545	SWITCH-SLIDE
1830	4822 267 11028	CONN. 16P, CD DRIVE

- CAPACITORS -

2250	2020 552 96305	4,7μF +80-20% Y5V 10V
2251	3198 017 41050	47nF 10% X7R 16V
2252	4822 126 14241	330pF 5% NPO 50V
2253	4822 126 14494	22nF 10% X7R 25V
2254	4822 126 13193	4,7nF 10% X7R 63V
2255	3198 017 41050	47nF 10% X7R 16V
2256	4822 124 12248	100μF 20% 4V
2257	2020 552 96305	4,7μF +80-20% Y5V 10V
2258	3198 017 41050	47nF 10% X7R 16V
2259	5322 126 11583	10nF 10% X7R 50V
2260	4822 122 31765	100pF 2% NP0 63V
2261	4822 126 14305	100nF 10% X7R 16V
2262	4822 122 31765	100pF 2% NP0 63V
2263	4822 126 13883	220pF 5% 50V
2264	4822 126 13883	220pF 5% 50V
2265	4822 126 14305	100nF 10% X7R 16V
2266	4822 126 13883	220pF 5% 50V
2267	4822 126 14305	100nF 10% X7R 16V
2268	4822 126 13883	220pF 5% 50V
2269	4822 126 14305	100nF 10% X7R 16V
2272	3198 017 41050	47nF 10% X7R 16V
2275	5322 126 11583	10nF 10% X7R 50V
2276	4822 126 14305	100nF 10% X7R 16V
2277	3198 017 41050	47nF 10% X7R 16V
2278	3198 017 41050	47nF 10% X7R 16V
2279	4822 126 14305	100nF 10% X7R 16V
2301	4822 126 13883	220pF 5% 50V
2302	4822 126 13883	220pF 5% 50V
2303	4822 126 13883	220pF 5% 50V
2304	4822 126 13883	220pF 5% 50V
2305	4822 122 31765	100pF 2% NP0 63V
2306	4822 122 31765	100pF 2% NP0 63V
2313	4822 126 14305	100nF 10% X7R 16V
2314	4822 126 14305	100nF 10% X7R 16V
2315	4822 126 14491	2.2μF 20% 10V

- CAPACITORS -

2316	4822 126 14491	2.2μF 20% 10V
2319	2222 867 15339	33pF 5% NP0 50V
2320	2222 867 15339	33pF 5% NP0 50V
2321	4822 124 12245	220μF 20% 10V
2322	4822 124 12245	220μF 20% 10V
2325	4822 122 31765	100pF 2% NP0 63V
2326	4822 122 31765	100pF 2% NP0 63V
2332	4822 124 11947	10μF 20% 16V
2333	4822 124 12362	47μF 20% 4V
2335	4822 124 40998	22μF 20% 6,3V
2339	4822 124 12362	47μF 20% 4V
2340	4822 124 22726	4,7μF 20% 35V
2341	4822 124 22726	4,7μF 20% 35V
2342	5322 126 11583	10nF 10% X7R 50V
2343	3198 017 41050	47nF 10% X7R 16V
2344	3198 017 41050	47nF 10% X7R 16V
2400	3198 017 41050	47nF 10% X7R 16V
2401	4822 126 14491	2.2μF 20% 10V
2402	4822 126 14305	100nF 10% X7R 16V
2403	4822 126 14305	100nF 10% X7R 16V
2404	4822 126 14305	100nF 10% X7R 16V
2405	4822 126 14305	100nF 10% X7R 16V
2700	4822 126 14305	100nF 10% X7R 16V
2701	5322 126 11578	1nF 10% X7R 50V
2702	5322 126 11583	10nF 10% X7R 50V
2800	4822 126 14491	2.2μF 20% 10V
2801	4822 126 13193	4,7nF 10% X7R 63V
2802	4822 124 40998	22μF 20% 6,3V
2803	4822 126 14305	100nF 10% X7R 16V
2804	4822 124 12362	47μF 20% 4V
2805	4822 126 14305	100nF 10% X7R 16V
2830	4822 124 40998	22μF 20% 6,3V
2831	4822 126 14508	180pF 5% 50V
2832	4822 126 14241	330pF 5% NPO 50V
2833	4822 126 14508	180pF 5% 50V
2834	4822 126 14508	180pF 5% 50V
2835	4822 126 14508	180pF 5% 50V
2836	4822 126 14508	180pF 5% 50V
2837	4822 126 13883	220pF 5% 50V
2838	4822 126 13883	220pF 5% 50V
2839	4822 126 13883	220pF 5% 50V
2840	4822 126 13883	220pF 5% 50V
2841	4822 126 13883	220pF 5% 50V
2842	4822 126 13883	220pF 5% 50V
2843	4822 124 40998	22μF 20% 6,3V
2844	4822 126 14305	100nF 10% X7R 16V
2845	3198 017 34730	47nF 10% X7R 16V
2846	5322 126 11578	1nF 10% X7R 50V
2847	4822 126 14494	22nF 10% X7R 25V
2848	4822 126 11669	27pF 5% 50V

ELECTRICAL PARTSLIST

- CAPACITORS -

2849	5322 126 11583	10nF 10% X7R 50V
2850	5322 126 11579	3,3nF10% X7R 63V
2851	5322 126 11579	3,3nF10% X7R 63V
2852	5322 126 11579	3,3nF10% X7R 63V
2853	4822 126 14247	1,5nF 5% X7R 50V
2854	4822 126 14247	1,5nF 5% X7R 50V
2855	5322 126 11579	3,3nF10% X7R 63V
2856	4822 126 14549	33nF 5% 16V
2857	4822 126 14305	100nF 10% X7R 16V
2858	4822 126 13344	1,5nF 5% 63V
2859	4822 124 12362	47µF 20% 4V
2860	4822 126 13344	1,5nF 5% 63V
2861	3198 017 41050	47nF 10% X7R 16V
2862	3198 017 41050	47nF 10% X7R 16V
2880	4822 126 14305	100nF 10% X7R 16V
2881	4822 126 14305	100nF 10% X7R 16V
2882	4822 126 14305	100nF 10% X7R 16V
2885	4822 126 14305	100nF 10% X7R 16V
2886	4822 124 40998	22µF 20% 6,3V
2887	4822 126 14549	33nF 5% 16V
2888	4822 126 14305	100nF 10% X7R 16V
2889	4822 122 33741	10pF 10% NP0 50V
2890	4822 126 13887	4,7pF 1% 50V
2892	4822 126 14305	100nF 10% X7R 16V
2893	4822 126 14549	33nF 5% 16V
2894	4822 126 13883	220pF 5% 50V

- RESISTORS -

3250	4822 051 30681	680R 5% 0,062W
3252	4822 051 30331	330R 5% 0,062W
3253	4822 051 30101	100R 5% 0,062W
3254	4822 117 12925	47K 1% 0,063W
3256	4822 051 30272	2,7K 5% 0,062W
3257	4822 117 12891	220K 1% ERJ3E
3258	4822 117 13632	100K 1% 0,062W
3259	4822 117 12891	220K 1% ERJ3E
3260	4822 051 30105	1M 5% 0,062W
3261	4822 051 30103	10K 5% 0,062W
3266	4822 051 30103	10K 5% 0,062W
3268	4822 051 30103	10K 5% 0,062W
3269	4822 051 30103	10K 5% 0,062W
3270	2322 702 70278	2,7R 5% RC21
3271	2322 702 70278	2,7R 5% RC21
3279	3198 021 32250	2,2M 5%
3280	4822 051 30474	470K 5% 0,062W
3281	4822 117 12925	47K 1% 0,063W
3282	4822 051 30474	470K 5% 0,062W
3283	4822 051 30474	470K 5% 0,062W

- RESISTORS -

3284	2322 615 13103	NTC 10K 5% 0,21W
3286	4822 051 30103	10K 5% 0,062W
3288	4822 051 30109	10R 5% 0,062W
3289	4822 051 30562	5,6K 5% 0,063W
3291	4822 117 13632	100K 1% 0,062W
3292	4822 051 30103	10K 5% 0,062W
3293	4822 051 30331	330R 5% 0,062W
3294	4822 051 30474	470K 5% 0,062W
3297	4822 051 30472	4,7K 5% 0,062W
3298	4822 051 30681	680R 5% 0,062W
3311	4822 051 30153	15K 5% 0,062W
3312	4822 051 30153	15K 5% 0,062W
3313	4822 051 30153	15K 5% 0,062W
3314	4822 051 30153	15K 5% 0,062W
3315	4822 051 30103	10K 5% 0,062W
3316	4822 051 30103	10K 5% 0,062W
3317	4822 051 30103	10K 5% 0,062W
3318	4822 051 30103	10K 5% 0,062W
3320	3103 308 53680	POTMETER 2X10K CX2
3323	4822 051 30123	12K 5% 0,062W
3324	4822 051 30123	12K 5% 0,062W
3326	4822 051 30008	0R JUMPER 0603
3327	4822 051 30472	4,7K 5% 0,062W
3328	4822 051 30472	4,7K 5% 0,062W
3333	4822 117 13632	100K 1% 0,062W
3334	4822 117 13632	100K 1% 0,062W
3337	4822 051 30472	4,7K 5% 0,062W
3338	4822 051 30472	4,7K 5% 0,062W
3339	4822 051 30563	56K 5% 0,062W
3340	4822 051 30563	56K 5% 0,062W
3341	4822 051 30184	180K 5% 0,062W
3342	4822 051 30184	180K 5% 0,062W
3343	4822 051 30331	330R 5% 0,062W
3344	4822 051 30331	330R 5% 0,062W
3345	4822 117 12971	15R 5% 0,062W
3346	4822 117 12971	15R 5% 0,062W
3347	4822 051 30331	330R 5% 0,062W
3348	4822 051 30331	330R 5% 0,062W
3349	4822 051 30008	0R JUMPER 0603
3350	4822 051 30008	0R JUMPER 0603
3360	4822 117 12925	47K 1% 0,063W
3361	4822 051 30183	18K 5% 0,062W
3362	4822 051 30682	6,8K 5% 0,062W
3364	4822 051 30008	0R JUMPER 0603
3365	4822 117 13632	100K 1% 0,062W
3366	4822 117 13632	100K 1% 0,062W
3367	4822 051 30103	10K 5% 0,062W
3368	4822 051 30103	10K 5% 0,062W
3370	4822 051 30474	470K 5% 0,062W
3371	4822 051 30474	470K 5% 0,062W

ELECTRICAL PARTSLIST

- RESISTORS -

3372	4822 051 30103	10K 5% 0,062W
3373	4822 117 13632	100K 1% 0,062W
3374	4822 117 13632	100K 1% 0,062W
3375	4822 117 12139	22R 5% 0,062W
3376	4822 117 12139	22R 5% 0,062W
3377	3198 021 32250	2,2M 5%
3378	3198 021 32250	2,2M 5%
3379	4822 117 13632	100K 1% 0,062W
3380	4822 051 30103	10K 5% 0,062W
3381	4822 051 30103	10K 5% 0,062W
3382	4822 051 30102	1K 5% 0,062W
3383	4822 051 30102	1K 5% 0,062W
3384	4822 117 13632	100K 1% 0,062W
3400	4822 117 13632	100K 1% 0,062W
3401	4822 117 12891	220K 1% ERJ3E
3402	4822 117 12891	220K 1% ERJ3E
3403	4822 117 12891	220K 1% ERJ3E
3404	4822 051 30102	1K 5% 0,062W
3405	4822 051 30102	1K 5% 0,062W
3406	4822 051 30102	1K 5% 0,062W
3407	4822 051 30154	150K 5% 0,062W
3408	4822 051 30123	12K 5% 0,062W
3409	4822 051 30153	15K 5% 0,062W
3409 #	4822 051 30562	5,6K 5% 0,062W
3410	4822 051 30109	10R 5% 0,062W
3411	4822 051 30109	10R 5% 0,062W
3412	4822 051 30101	100R 5% 0,062W
3413	4822 051 30101	100R 5% 0,062W
3414	4822 117 12925	47K 1% 0,063W
3418	4822 051 30008	0R JUMPER 0603
3421	4822 117 12891	220K 1% ERJ3E
3422	4822 051 30153	15K 5% 0,062W
3700	3198 021 32250	2,2M 5%
3701	4822 051 30334	330K 5% 0,062W
3702	3198 021 32250	2,2M 5%
3703	4822 051 30105	1M 5% 0,062W
3704	4822 051 30105	1M 5% 0,062W
3707	3198 021 32250	2,2M 5%
3708	4822 051 30103	10K 5% 0,062W
3709	4822 051 30334	330K 5% 0,062W
3710	3198 021 32250	2,2M 5%
3800	4822 117 13608	4,7R 5% 0,0016W
3801	4822 051 30153	15K 5% 0,062W
3802	4822 051 30683	68K 5% 0,062W
3803	4822 051 30332	3,3K 5% 0,062W
3804	4822 051 30479	47R 5% 0,062W
3805	4822 051 30472	4,7K 5% 0,062W
3806	4822 051 30332	3,3K 5% 0,062W
3807	4822 051 30471	470R 5% 0,062W
3808	4822 117 12891	220K 1% ERJ3E

- RESISTORS -

3809	4822 051 30563	56K 5% 0,062W
3830	4822 051 30109	10R 5% 0,062W
3831	4822 051 30562	5,6K 5% 0,063W
3832	4822 051 30562	5,6K 5% 0,063W
3833	4822 051 30562	5,6K 5% 0,063W
3834	4822 051 30562	5,6K 5% 0,063W
3835	4822 051 30273	27K 5% 0,062W
3836	4822 051 30273	27K 5% 0,062W
3837	4822 051 30333	33K 5% 0,062W
3838	4822 051 30333	33K 5% 0,062W
3839	4822 051 30333	33K 5% 0,062W
3840	4822 051 30333	33K 5% 0,062W
3841	4822 051 30103	10K 5% 0,062W
3842	4822 051 30103	10K 5% 0,062W
3843	4822 051 30103	10K 5% 0,062W
3844	4822 051 30103	10K 5% 0,062W
3845	4822 051 30103	10K 5% 0,062W
3846	4822 051 30103	10K 5% 0,062W
3847	4822 051 30339	33R 5% 0,062W
3848	4822 051 30333	33K 5% 0,062W
3849	4822 051 30102	1K 5% 0,062W
3850	4822 051 30223	22K 5% 0,062W
3851	4822 051 30102	1K 5% 0,062W
3852	4822 051 30109	10R 5% 0,062W
3853	4822 051 30109	10R 5% 0,062W
3854	4822 051 30222	2,2K 5% 0,062W
3855	4822 051 30222	2,2K 5% 0,062W
3856	4822 051 30222	2,2K 5% 0,062W
3857	4822 051 30222	2,2K 5% 0,062W
3858	4822 051 30222	2,2K 5% 0,062W
3859	4822 051 30222	2,2K 5% 0,062W
3860	4822 051 30103	10K 5% 0,062W
3861	4822 051 30103	10K 5% 0,062W
3862	4822 051 30103	10K 5% 0,062W
3863	4822 051 30103	10K 5% 0,062W
3864	4822 051 30103	10K 5% 0,062W
3865	4822 051 30332	3,3K 5% 0,062W
3867	4822 117 12139	22R 5% 0,062W
3868	4822 117 12139	22R 5% 0,062W
3869	4822 051 30479	47R 5% 0,062W
3871	4822 051 30008	0R JUMPER 0603
3872	4822 051 30008	0R JUMPER 0603
3873	4822 051 30008	0R JUMPER 0603
3874	4822 051 30105	1M 5% 0,062W
3875	4822 051 30472	4,7K 5% 0,062W
3878	4822 051 30008	0R JUMPER 0603
3880	4822 117 12139	22R 5% 0,062W
3882	4822 051 30008	0R JUMPER 0603
3883	4822 051 30008	0R JUMPER 0603
3884	4822 051 30008	0R JUMPER 0603

ELECTRICAL PARTSLIST**- RESISTORS -**

3885	4822 051 30103	10K 5% 0,062W
3886	4822 051 30103	10K 5% 0,062W
3887	4822 117 12139	22R 5% 0,062W
3888	4822 117 13632	100K 1% 0,062W
3890	4822 117 12139	22R 5% 0,062W
3909	4822 051 30008	0R JUMPER 0603
3910	4822 051 30103	10K 5% 0,062W
4205	4822 051 30008	0R JUMPER 0603
4206	4822 051 30008	0R JUMPER 0603
4207	4822 051 30008	0R JUMPER 0603
4208	4822 051 30008	0R JUMPER 0603
4210	4822 051 10008	0R JUMPER 1206

- COILS & FILTERS -

5250	2422 536 00346	IND VAR 40 μ H
5251	4822 157 51462	10 μ H 10% LAL04T
5800	4822 157 11074	100 μ H
1840	2422 540 98555	RES CER 33.868MHZ

- DIODES -

6252	5322 130 81917	SB140
6257	5322 130 81917	SB140
6300	4822 130 11551	UDZS10B
6301	5322 130 34331	BAV70
6302	5322 130 34331	BAV70
6303	4822 130 11397	BAS316
6400	4822 130 11397	BAS316

- IC & TRANSISTORS -

7250	9322 003 64676	TBC337-40
7251	5322 130 44647	BC368
7252	5322 130 44593	BC369
7255	5322 130 61569	BC868
7256	9322 171 12671	SC111259AFTA
7259	5322 130 42756	BC857C
7260	3198 010 42310	BC847BW
7300	9322 142 72685	TC75W51FU
7301	4822 209 33165	TDA1308T/N1
7302	3198 010 42310	BC847BW
7303	4822 130 42615	BC817-40
7304	4822 130 42615	BC817-40
7305	3198 010 42310	BC847BW
7306	3198 010 42310	BC847BW
7308	3198 010 42310	BC847BW
7309	4822 130 42615	BC817-40
7310	4822 130 42615	BC817-40
7311	5322 130 60123	BC807-40
7400	3140 110 51521	TMP86CH21F-FOCUS
7401	5322 130 42756	BC857C
7700	5322 130 42756	BC857C
7701	3198 010 42310	BC847BW
7702	3198 010 42310	BC847BW
7800	4822 209 17286	TZA1024T/N1
7801	3198 010 42310	BC847BW
7830	9352 641 80557	SAA7324H/M2B
7831	5322 130 42756	BC857C
7880	9322 169 78671	SM5907AF
7881	9322 175 89668	MSM51V17405F-60SJ
7882	3198 010 42310	BC847BW

Note: Only these parts mentioned in the list are normal service parts.